

# CHAPTER 12 – RIGHT OF WAY PERMITTING AND CONSTRUCTION STANDARDS FOR FACILITIES LOCATED IN PUBLIC RIGHT OF WAY

## 12.1 GENERAL

### 12.1.1 Purpose

The purpose of this chapter is to:

- Provide instructions on how to prepare and submit plans and other documentation for Right-of-Way Permits;
- Describe processes, policies and requirements; and
- Define roles and responsibilities of all parties.

### 12.1.2 Introduction

All contractors and public utility agencies must obtain a Right-of-Way Permit for any work performed within the public rights-of-way of the Larimer County. The storage of materials and equipment within the public rights-of-way also requires a Permit.

To preserve the original investment of the roadway systems within Larimer County, minimize the disruption and maximize the safety to the traveling public caused by construction, and reduce future maintenance problems, it is the policy of Larimer County to require the installation of new utilities across existing roads to be done by boring or tunneling. Open cutting of existing roads for the installation of new utilities will be permitted only when it can be proven it is not possible to use boring or tunneling techniques.

Applicants for Right-of-Way Permits must plan for adequate time for review and approval by the County and any other involved agencies. Generally, the greater the scope of work, the longer the permit review and approval process will take.

**NOTE: THE COUNTY RESERVES THE RIGHT TO VARY FROM THESE STANDARDS BASED UPON CONDITIONS SPECIFIC TO THE LOCATION WHERE THE WORK WILL OCCUR. THE "SPECIAL CONDITIONS" SECTION OF THE PERMIT WILL OUTLINE ANY VARIATIONS FROM THE COUNTY-WIDE SPECIFICATIONS.**

### 12.1.3 Applicability

These standards shall apply to all area within the unincorporated area of Larimer County.

### 12.1.4 Specific Conditions

#### ***12.1.4.1 Traffic Flow During Peak Hours***

No interference with traffic flow on arterial or collector roads shall be permitted during the hours of 7:00 a.m. to 8:30 a.m. or from 4:30 p.m. to 5:30 p.m. unless authorized in writing by the Engineer.

#### **12.1.4.2 End of Day Lane Conditions**

- a. **ASPHALT ROAD** - When work is stopped for the day, all lanes of an arterial or collector road shall be opened to traffic unless approved by the Engineer. A traffic lane shall be considered satisfactorily open only if it is paved with hot or cold mix asphalt paving, except when an alternative temporary surface is allowed by the County as a condition of the permit.
- b. **CONCRETE ROAD** - When work is stopped for the day, all lanes of an arterial or collector road shall be opened for traffic. A traffic lane shall be considered satisfactorily open only if it is surfaced with a temporary asphalt surface. In the event the road surface has been replaced in the same day as the excavation was made, the repaired areas should be properly barricaded to protect the concrete during the curing stage.

#### **12.1.4.3 Inspection Requests**

It shall be the responsibility of the person performing the work authorized by the permit to notify the Engineer that such work is ready for inspection. The Engineer requires that every request for inspection be received at least twenty-four (24) hours before such inspection is desired. Such requests may be in writing or by telephoning or faxing the Engineer.

#### **12.1.4.4 Minimum Concrete Removals / Replacements**

Removal and replacement shall be to existing joints.

#### **12.1.4.5 Road Closures**

Road closures will only be allowed at the approval of the Engineer.

### **12.1.5 Permit Fees**

The County's permit fees are established under appropriate enabling resolutions and/or ordinances and are subject to change periodically. A complete fee schedule for Larimer County can be found on the County's website.

<http://larimer.org/engineering/utility/index.htm>

An additional fee may be charged for any excavation work that may affect the accuracy of the County's Survey Monumentation System.

### **12.1.6 Insurance Requirements**

The Permit Applicant is required to submit certificates of insurance for Commercial General Liability and Automobile Liability. These requirements can be obtained at the Engineering office or at the County's website.

[http://larimer.org/engineering/utility/Insurance\\_Requirements.pdf](http://larimer.org/engineering/utility/Insurance_Requirements.pdf)

## **12.2 PERMIT APPLICATION PROCESS**

### **12.2.1 Permit Forms**

Blank permit forms and instructions for completing the forms can be obtained at the Engineering office or at the County's website.

<https://onlineportal.larimer.org/Public/Main>

## **12.2.2 Submissions of Plans**

### **12.2.2.1 Required Plans**

Drawings or plans that clearly indicate the proposed work must be attached to the permit application. These drawings must be to a working scale and must show position and location of work, road names/numbers, widths of roads, property lines, topographic and man-made features, existing drainage patterns, etc. Plans shall show the relative position of proposed work to existing utilities and existing improvements and shall be drawn to a scale of one (1) inch = fifty (50) feet or larger and shall include a north reference.

### **12.2.2.2 Exceptions**

Minor maintenance projects may be exempt from submitting formal construction plans. In such cases however, sketch plans must accompany the permit application. Utility companies may be exempt from the requirement of a professional engineer's signature and stamp on the construction plans if the project is of a nature that would not warrant design by a registered professional engineer. Requirements for submitting plan and profile sheets may be waived upon written request of the utility company.

### **12.2.2.3 Supporting Documentation**

Specific project supporting documentation may be requested by the County as part of any permit application. This may include, but is not limited to, design and construction specifications, geotechnical investigations, traffic impact studies, etc.

## **12.2.3 Submissions of Traffic Control Plans**

Traffic Control Plans shall show in detail the proposed work area location and the traffic control devices being proposed. Such plan shall be on paper at least 8 1/2 inches by 11 inches and may be faxed, mailed or brought to the County Engineering office prior to, or with the completed permit application. Traffic Control Plans may require more detail than normal at the discretion of the Engineer due to unique or unusual conditions. Traffic control shall also include construction traffic routing requirements. Plans must be prepared by a certified Traffic Control Supervisor (TCS).

## **12.2.4 Other Permits**

Permit Applicants are responsible for obtaining separate permits or permission as may be required. Examples may be when work is proposed within a state highway, railroad or irrigation company right-of-way, or private property.

## **12.3 CONSTRUCTION DETAILS**

### **12.3.1 General Conditions**

The following general conditions apply to all work done within the public rights-of-way such as utility line installation or repairs performed by any contractor or utility department, public or private.

### **12.3.1.1 Protection of Existing Improvements**

- a. The Contractor shall at all times take proper precautions and be responsible for the protection of existing road and alley surfaces, driveway culverts, road intersection culverts or aprons, irrigation systems, mail boxes, driveway approaches, curb, gutter and sidewalks and all other identifiable installations that may be encountered during construction.
- b. The Contractor shall, at all times, take proper precautions for the protection of existing utilities, the presence of which are known or can be determined by field locations of the utility companies. The Contractor shall contact **UNCC (One Call) at 1-800-922-1987** for utility locates a minimum of two (2) working days prior to his proposed start of work.
- c. Existing improvements to adjacent property such as landscaping, fencing, utility services, driveway surfaces, etc. that are not to be removed shall be protected from injury or damage resulting from the Contractor's operations.
- d. The Contractor shall at all times take proper precautions for the protection of property pins/corners and survey control monuments encountered during construction. Any damaged or disturbed survey markers shall be replaced by a registered land surveyor at the Contractor's expense.
- e. The repair of any damaged improvements as described above shall be the responsibility of the permit holder.
- f. The Contractor shall make adequate provisions to assure that traffic and adjacent property owners experience a minimum level of inconvenience

### **12.3.1.2 Temporary Surfaces Required**

When the final surface is not immediately installed, it shall be necessary to place a temporary asphalt surface on any road cut opening. The temporary surface installation and maintenance shall be the responsibility of the Permit holder or Contractor until the permanent surface is completed and accepted. It shall be either a hot mix or cold mix paving material. Temporary surfaces shall be compacted, rolled smooth and sealed to prevent degradation of the repair and existing structures during the temporary period. Permanent patching shall occur within two (2) weeks except as outlined by the County in the Permit.

### **12.3.1.3 Pavement Patches**

All permanent pavement patches and repairs shall be made with "in kind" materials. For example, concrete patches in concrete surfaces, full depth asphalt patches with full depth asphalt, concrete pavement with asphalt overlay patches will be expected in permanent "overlaid" concrete roads, etc. In no case is there to be an asphalt patch in concrete roads or concrete patch in asphalt roads. Any repair not meeting these requirements will be removed and replaced by the Contractor at his expense. Refer to Section 4 for details.

### **12.3.1.4 Work to be Done in Expedient Manner**

All work shall be done in an expedient manner. Repairs shall be made as rapidly and consistent with high quality workmanship and materials. When repair is contemplated, use of fast-setting concrete or similar techniques is encouraged whenever possible without sacrificing quality of repair. Completion of the work including replacement of pavement and cleanup shall normally be accomplished within two (2) weeks after the repair work. Extension of time for completion shall be

with the written approval of the Engineer. If the repairs are not completed in the allotted time, the County has the right to repair the road at the Contractor's expense.

#### **12.3.1.5 Removal and Replacement of Unsatisfactory Work**

Removal and replacement of unsatisfactory work shall be completed within fifteen (15) days of written notification of the deficiency unless deemed an emergency requiring immediate action. In the event the replacement work has not been completed, the County will take action upon the Contractor's bond to cover all related costs.

#### **12.3.1.6 Tolerances**

As a standard of practice, all utility services shall be extended beyond the pavement surface or to the right-of-way line to facilitate connections at a future date. All manhole lids, access covers, valve boxes, etc. shall be placed ¼-inch to 1/2-inch below the adjacent finished road surface.

### **12.3.2 Excavation**

1. Excavation shall consist of removal of all material necessary for the construction of the roadway section to the subgrade elevation, line, and grade shown on the plans or as specified in the contract documents. Unacceptable material defined as any earthen material containing vegetable or organic silt, topsoil, frozen material, trees, stumps, certain man-made deposits, or industrial waste, sludge or landfill, or other undesirable materials will be removed from the site and disposed of in accordance with applicable County, State and Federal requirements. All tree stumps and roots shall be removed to a minimum of two (2) feet below subgrade.
2. Any work on trees, including roots, must be reviewed by the County.
3. Excavation shall be performed in a careful and orderly manner with due consideration given to protection of adjoining property, and the public. Any damage to roads, parking lots, utilities, irrigation systems, plants, trees, buildings or structures, private property, construction stakes or bench marks, due to the negligence of the Contractor, shall be repaired and restored to its original conditions by the Contractor at his expense. Those areas that are to be saved will be clearly fenced off by the Contractor per the owner's instructions. It will be the Contractor's responsibility to ensure that these areas are not damaged during the construction process. Following completion of construction, should any of these trees, shrubs or irrigation facilities, etc. require replacement, it shall be done at the Contractor's expense.
4. All materials determined acceptable by the Engineer acquired from roadway excavations may be used for embankment fill and backfill as needed. The entire area in the vicinity of the construction where excavation and filling has been performed shall be raked clean of all trash, wood forms, and debris, after completion of the work with no additional cost to the Owner. Material removed in excavation and not acceptable or not required for embankment fill or backfill shall be disposed of by the Contractor. It shall not be wasted on private property without written permission of the property owner. Waste banks shall be left with reasonable smooth and regular surfaces.
5. The construction of any repair activity within the road or alley rights-of-way shall be accomplished by open cut, jacking, boring, tunneling or a combination of

- these methods as approved by the permit. The Engineer shall approve any change from the approved permit.
6. Trenches shall be excavated along the lines and grades established and in no case shall be more than two hundred (200) feet in length, or be trenched or backfilled in non-continuous sections unless approved by the Engineer. Failure by the Contractor to comply with these requirements may result in an order to stop the excavation in progress until compliance has been achieved.
  7. All excavated material shall be stockpiled in a manner that does not endanger the work or workers and that does not obstruct sidewalks, roads and driveways. No stockpiled materials shall be allowed on the asphalt surface or adjacent walkways. The work shall be done in a manner that will minimize interference with traffic and/or drainage of the road. The Contractor at the end of each day shall barricade all excavations and ditch lines, remove excess material from travel ways, and thoroughly clean all road, alleys and sidewalks affected by the excavation. If it becomes necessary, all roads, alleys (if asphalt or concrete) and sidewalks shall be swept or washed as required by the Engineer.
  8. Materials encountered during excavation such as rubbish, organic, or frozen material, and any other material that is not satisfactory for use as backfill in the opinion of the Engineer, shall be removed from the site and disposed of daily by the Contractor at his expense. Stones, concrete or asphalt chunks larger than six (6) inches or frozen material shall be considered unsatisfactory backfill and removed by the Contractor.
  9. All excavation, shoring and trenching shall comply with OSHA's "Construction Industry Standards" as well as all applicable Federal and State regulations.
  10. No tracked vehicles shall be allowed on asphalt or concrete unless approved by the Engineer.
  11. Crossings under sidewalks or curbs may be made by tunneling only when approved by the Engineer. If the Contractor elects to remove a portion of the sidewalk or curb, the applicable County standards shall be followed.
  12. Grading shall be done as necessary to prevent surface water from entering the excavation; any other water accumulation therein shall be promptly removed. Surface drainage flowing from adjoining areas shall be kept unobstructed.
  13. When soft or unstable material or rock is encountered in the trench subgrade, that will not uniformly support the pipe, this material shall be excavated to additional depths directed by the Engineer and backfilled with Type B material, as described in Subsection 12.3.7.2.

### **12.3.3 Blasting**

The Contractor's blasting procedures shall conform to Federal, State, and local ordinances. The Contractor shall obtain all required permits prior to the start of blasting.

Blasting for excavation will be permitted only after securing the approval of the Engineer. The Engineer will fix the hours of blasting. The Contractor shall use the utmost care to protect life and property. All explosives shall be safely and securely stored in compliance with local laws and ordinances, and all storage places shall be clearly marked "Dangerous Explosives". No explosives shall be left unprotected where they could endanger life or property.

When blasting in trenches, the Contractor shall cover the area to be shot with earth backfill or approved blasting mats. Prior to blasting, the Contractor shall station flaggers and provide signals of danger in suitable places to warn people and stop vehicles. The Contractor shall be responsible for all damage to property and injury to persons resulting from blasting or accidental explosions that may occur in connection with the use of explosives.

#### **12.3.4 Equipment**

1. The use of trench digging equipment will be permitted in places where its operation will not cause damage to existing structures or features, in which case hand methods shall be employed.
2. No tracked vehicles shall be permitted on roads unless approved by the Engineer. When tracked vehicles are allowed, existing facilities will be restored to original condition at the Contractor's expense.
3. Construction equipment and material delivery routing will be made a condition of the Permit.

#### **12.3.5 Dewatering**

Where ground water is encountered in the excavation, it shall be removed to avoid interfering with the work. It is the Contractor's responsibility to comply with all Federal, State and local permitting requirements prior to beginning any dewatering operations.

#### **12.3.6 Removals**

##### ***12.3.6.1 Roads, Paved***

- a. Bituminous pavement shall be saw cut to clean, straight lines and should be perpendicular or parallel to the flow of traffic. (See Section 12.4.2.2.a)
- b. In existing pavement, all excavations within 36" of the edge of the asphalt shall require removal and replacement from the edge of asphalt to the excavation edge.
- c. Concrete pavement, cross pans, driveways, roads and alleys shall be removed to neatly sawed edges cut to full depth.

##### ***12.3.6.2 Roads, Gravel***

- a. When trenches are excavated in roads or alleys which have only a gravel surface, the Contractor shall replace such surfacing on a satisfactory compacted backfill with gravel conforming to CDOT Class 5 or Class 6 aggregate base course. Gravel replacement shall be one (1) inch greater in depth to that which originally existed, but not less than four (4) inches. The surface shall conform to the original road grade. Where the completed surface settles, additional gravel base shall be placed and compacted by the Contractor immediately after being notified by the County, to restore the roadbed surface to finished grade.
- b. Some roads may have been treated with a special surface treatment to control dust and/or bind the aggregates together. In these cases, the Contractor is responsible for restoring the gravel surface to its existing stabilized condition. Such surface treatments shall be of the same chemical

composition as what existed prior to the excavation work. The Engineer shall note on the permit the surface treatment that will be required.

### **12.3.6.3 Concrete Curb, Gutter and Sidewalk**

Concrete shall be removed to neatly sawed edges to full depth for sidewalks and curb and gutter and shall be saw-cut in straight lines either parallel to the curb or perpendicular to the alignment of the sidewalk or curb. Removal shall be done to the nearest joint or as directed by the Engineer. Replaced sections may require doweled connections as directed by the Engineer.

## **12.3.7 Backfill**

### **12.3.7.1 Flowable-Fill**

FLOWABLE-FILL WILL BE REQUIRED AS UTILITY TRENCH BACKFILL FOR ALL TRENCHES UNLESS OTHERWISE APPROVED BY THE ENGINEER.

Refer to Section 5 for compaction requirements. This requirement applies to all pavement and gravel locations. Flowable-fill vibration may be required.

The recommended mix for flowable-fill is shown in Table 12-1 below. Concrete backfill will not be allowed within the public right-of-way. Other alternatives to flow fill may be used if approved by the Engineer. Refer to CDOT specification 206.

**Table 12-1  
Recommended Mix for Flowable Fill**

<b>INGREDIENTS</b>	<b>POUNDS/CUBIC YARD</b>
Cement	42 (0.47 sack)
Water	235 (39 gallons or as needed)
Coarse Aggregate (Size No. 57)	1700
Sand (ASTM C-33)	1845

The maximum desired 28-day strength is 60 psi. The above combination of material, or an equivalent, may be used to obtain the desired "flowable-fill".

Flowable-fill is prohibited as a temporary or permanent road surface. Trenches shall initially be backfilled to the level of the original surface. After the flowable-fill has cured, the top surface of the flowable-fill shall be removed and the temporary or permanent surface shall be placed.

Bridging and cutback requirements as described in these standards may still be required if the road failures indicate a clear need.

Repair of failed trenches will be the responsibility of the party requiring the trench.

### **12.3.7.2 Conventional Backfill (Other than Flowable Fill)**

When "non flowable-fill" backfill material has been pre-approved by the Engineer, backfill in existing or proposed roads, curbs, gutters, sidewalks and alleys is divided into three (3) categories: initial, intermediate and final lifts as defined below:



- a. The INITIAL LIFT, designated as Class B and generally comprised of a washed, clean gravel material, consists of the section from the bottom of the excavation to a point six to twelve (6 - 12) inches above the top of the installation. Placement and compaction of the initial layer shall be as specified by the utility to protect their installation.
- b. The INTERMEDIATE LIFT, generally comprised of native material, consists of the section above the initial layer to a point within six (6) inches of the ground level or the bottom of the pavement section whichever is greater. Excavated material may be used in the intermediate layer provided that it is deemed suitable by the Engineer.
- c. The FINAL LIFT includes both road base and asphalt surfacing. Road base material shall be CDOT Class 5 or 6 aggregate base course or as specified by the Engineer.
- d. Maximum dry density of all soil types used will be determined in accordance with AASHTO T 99 or AASHTO T 180. These densities will be determined prior to placement of backfill.
- e. When a hydro-hammer or drop hammer compaction machine is used for compaction of fill in trenches, the maximum layer shall be 30 inches.

#### **12.3.7.3 Compaction Testing Requirements**

See "Testing" Section 12.5

#### **12.3.7.4 Embankment and Slopes**

- a. The Engineer shall approve all fill material.
- b. All cut slopes shall conform to OSHA standards.

### **12.3.8 Restoration**

#### **12.3.8.1 Bore Holes – Vertical and Horizontal**

- a. For openings less than or equal to 6" in diameter, bore holes shall be filled with patching material (**cold mix is not acceptable**) to prevent entry of moisture. Patching material used shall be in all cases compatible with the existing surface. Subgrade shall be replaced with flowable fill to provide necessary support to the surface. The sealing of bore holes is the responsibility of the Contractor or persons making the bore.
- b. For openings greater than 6" in diameter, the limits of repair shall be identified in the permit.
- c. The completed job shall be flush with the surrounding pavement and have no indentations, pockets, or recesses that may trap and hold water.

#### **12.3.8.2 Subgrade**

- a. **Placement.** The subgrade for the pavement structure shall be graded to conform to the cross sections and profile required by the construction plans. Prior to the placement of aggregate base course or sub-course, the subgrade should be properly prepared. The subgrade should be scarified to a minimum depth of six (6) inches, moisture adjusted as necessary, and recompacted to not less than the following:

- 1) For cohesive soils, 90% maximum Modified Proctor dry density at 2% of optimum moisture content, or 95% maximum Standard Proctor dry density at 2% of optimum moisture content.
  - 2) For non-cohesive soils, 92% maximum Modified Proctor dry density at 2% of optimum moisture content, or 97% maximum Standard Proctor dry density at 2% of optimum moisture content.
  - 3) For expansive soils, 88% maximum Modified Proctor dry density at 3% or greater above optimum moisture content, or 93% maximum Standard Proctor dry density at 1% or greater above optimum moisture content. For highly expansive soils (swell potential 2% under 200 psf surcharge pressure), paving will not be permitted without a subgrade treatment approved by the Engineer.
- b. **Compaction.** Prior to approval to place the base or sub-base course, all utility main and service trenches shall be compacted to not less than the above referenced densities required for the given soil classification. This density requirement also applies to all utility trenches within the public rights-of-way from a point four (4) feet beyond the edge of asphalt and descending at 1:1 outward.

#### **12.3.8.3 Asphalt Surfacing**

- a. **Placement.** Any damage, even superficial, to the existing asphalt surface in the vicinity of the work shall be repaired at the expense of the Contractor, including but not limited to gouges, scrapes, outrigger marks, backhoe bucket marks, etc. A slurry seal type covering will be considered the minimum repair. Patching may be required, at the discretion of the Engineer.
- 1) The depth of asphalt patches in asphalt roads shall typically be the depth of the existing asphalt surface plus two (2) inches or as specified by the Engineer.
  - 2) The asphalt patch area for road excavations that fall within the wheel path of the vehicular travel lane shall be increased in size to the center of the lane or adjacent lane. In no circumstance will the edge of a patch area be allowed to fall within the wheel path.
  - 3) Chip-sealed roads shall be treated as paved when considering an approach to repair and patching. As such, repair strategies shown in Section 12.4 shall be applied to chip-sealed roads. Full width repairs may be required by the Engineer to avoid rapid deterioration encountered with half-road patches.
  - 4) Minimum depth of patching.
    - i. Chip-sealed road – 4 inches
    - ii. Local road – 4 to 6 inches
    - iii. Collector/Minor Arterial road – 6 to 8 inches
    - iv. Arterial road – 8 to 10 inches
  - 5) All road cuts shall be patched as per the requirements of Section 12.4 below.
  - 6) For roads that are less than five (5) years old the County reserves the right to deny any road excavation or require repairs that are over and above these specifications.

- b. **EXCEPTIONS** - There may be situations where the patching standards are considered inappropriate. For example, rebuilding half of a road today when the road is due for reconstruction at a different profile in 2-3 years would constitute the Engineer modifying the patching requirements. In these cases, the Permit Holder may be allowed to provide a more modest patch adequate to accommodate traffic for the 2-3 year period. In return, the Permit Holder may be required to make a financial contribution to the road maintenance, rehabilitation or reconstruction program to support the more permanent improvements that are anticipated. This determination shall be made by the Engineer.
- c. **DISPUTE RESOLUTION** - Mutual acceptance of these standards is expected to evolve over time with experience in the field. Disagreements over requirements and cost sharing are inevitable. In cases where agreement cannot be reached, the dispute shall not relieve the Contractor from compliance to the specific Permit or standards provided by this document unless approved by the Engineer.

#### **12.3.8.4 Concrete Surfacing and Patching**

- a. Concrete pavement shall be replaced with 4,000 psi concrete to match the finish and thickness of the existing pavement, but not less than eight (8) inches thick. All concrete construction shall be protected from vehicular traffic, including contractor vehicles, until the concrete has achieved eighty (80) percent of its ultimate strength. Concrete shall be coated and sealed with a uniform application of membrane curing compound applied in accordance with manufacturer's recommendations.
- b. The use of quick curing concrete (3000 psi strength within 48 hours) shall be used on all arterial and collector roads when repair areas are less than 500 square feet or when temperatures are below 40° F. Quick curing concrete repairs may be opened to traffic within two (2) days or when the concrete has achieved eighty (80) percent of its design strength.
- c. Where existing cracks or damage is adjacent to the area being repaired, the repair area shall include the cracked or damaged concrete. Pavement repairs shall include all areas of damage, including leak test holes, pot holes, equipment and/or material scaring of the exiting surface.
- d. When repairing concrete, the removal perimeter shall be saw-cut and doweled prior to placement of new concrete as directed by the Engineer.

#### **12.3.8.5 Joint Filling**

- a. **Asphalt.** Following placement of the asphalt surface, the joints where the new asphalt abuts the old shall be sealed with a fog or painted coat of bitumen cement.
- b. **Concrete.** Joints shall be thoroughly cleaned of all foreign material then filled with a hot-poured elastic type joint filler conforming to M 173, ASTM D1190-80 or ASTM D1751-83, D1752-84, D3405-78, D3406-78, D3407-78 or silicone sealants or others as approved by the Engineer. Joint material shall be filled to within 1/2 inch of the surface. Excess material shall be scraped off to provide a smooth riding surface.

## 12.4 DEVELOPING A “QUALITY” APPROACH TO ROAD REPAIRS

### 12.4.1 General

Every road and road repair situation is unique. Design criteria and construction standards cannot address every situation but, in order to maintain some form of consistency, these standards have been developed. In most cases, they provide the minimum acceptable standards for construction or repair. Consequently, when strictly applied, they will provide the minimum acceptable product. Therefore, this criteria has been developed to maintain the same integrity of the road pavement and subsurface condition prior to its being cut for utility installations.

To achieve the goal of “Quality” or “Excellence” in road repairs, these criteria shall be viewed as minimum standards when used in conjunction with good planning and judgment. This will restore the road to an acceptable condition with minimal patching failures. In most cases, it will be necessary to exceed the minimum standards to achieve a quality repair.

Issues that shall be considered in a quality approach to road repairs are as follows:

### 12.4.2 Appearance

Does the final appearance of the road suggest the repairs were planned, or that they happened by accident?

1. Consciously or not, the driving public “rates” the appearance of the road system, including road repairs, every day. Road repairs which are not done satisfactorily from a functional point of view may produce a negative reaction from the public if they give the appearance of being poorly planned or executed.
2. The public’s perception of road repairs is based primarily on shape, size, and orientation -- the geometry of a patch. The following shall be considered minimum standards for the geometry of a quality patch:
  - a. Existing pavements should be removed to clean, straight lines parallel and perpendicular to the flow of traffic. Do not construct patches with angled sides and irregular shapes.

**NOT ACCEPTABLE**

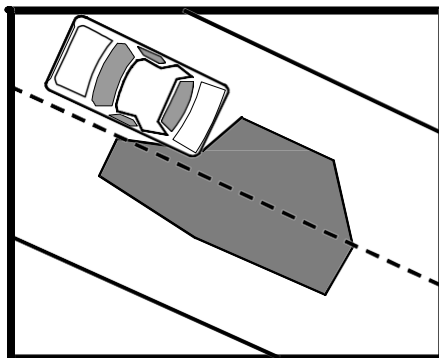

**ACCEPTABLE**

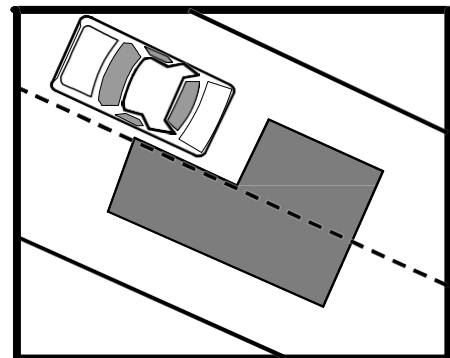

- b. Avoid patches within existing patches. If this cannot be avoided, make the boundaries of the patches coincide.

**NOT ACCEPTABLE**

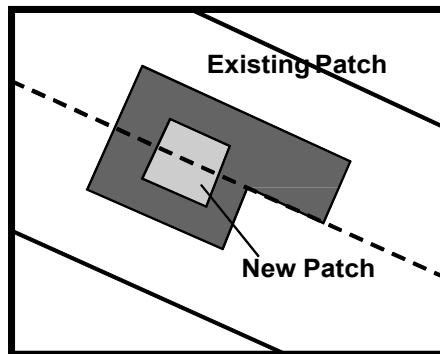

**ACCEPTABLE**

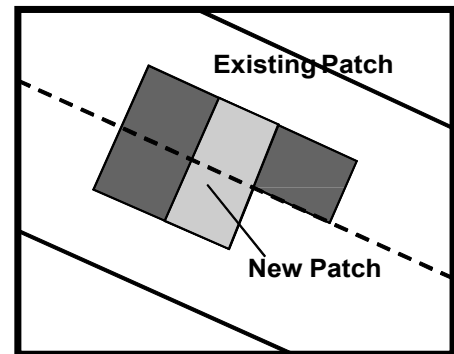

- c. Do not “leave” strips of pavement less than one-half lane in width from the edge of the new patch to the edge of an existing patch or the lip of the gutter.

**NOT ACCEPTABLE**

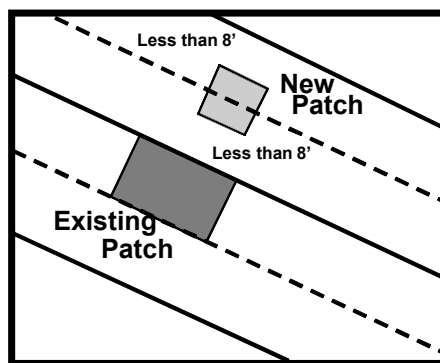

**ACCEPTABLE**

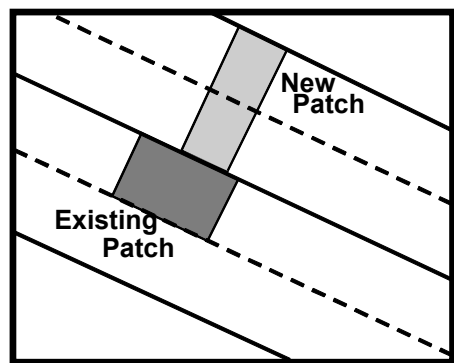

- d. In concrete pavements, remove sections to existing joints – repair “panels”. In damaged concrete, the limits of removal should be determined in the field by a representative or the Engineer.

**NOT ACCEPTABLE**

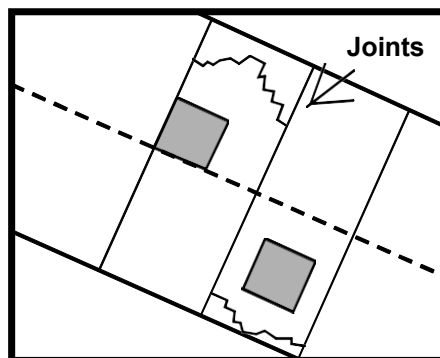

**ACCEPTABLE**

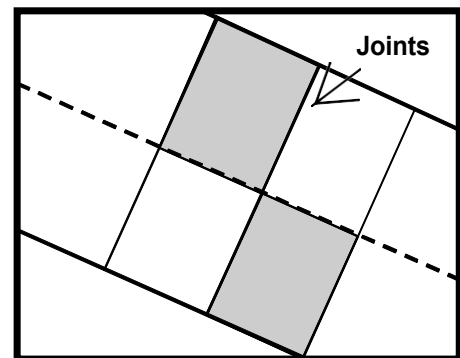

- e. Asphalt and concrete pavements should be removed by saw cutting or grinding. Avoid breaking away the edges of the existing pavement or damaging the remaining pavement with heavy construction equipment.

**NOT ACCEPTABLE**

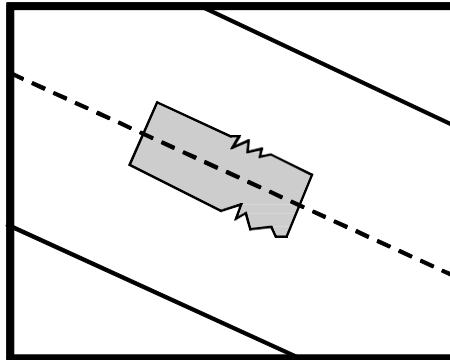

**ACCEPTABLE**

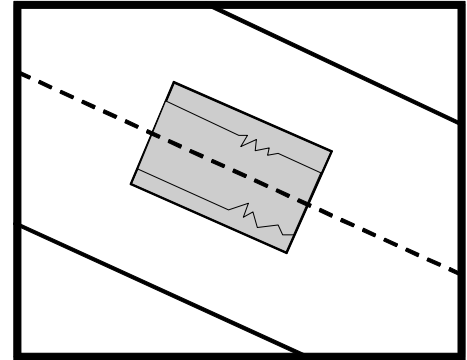

- f. In the case of a series of patches or patches for service lines off a main trench, repair the pavement over the patches by grinding and overlay when the spacing between the patches is less than 75 feet (in cases where the existing pavement is in poor condition and may require overlay within the next few years, this requirement may be modified or waived by the Engineer).

**NOT ACCEPTABLE**

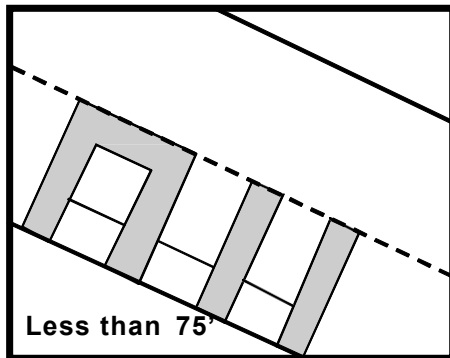

**ACCEPTABLE**

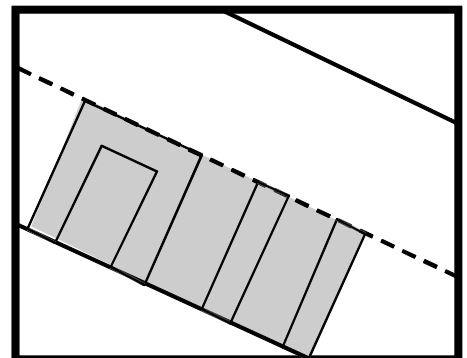

**12.4.3 Rideability**

Are the transitions on and off of the repair smooth? Does the patch itself offer a smooth ride? Are the joints located outside of the normal wheel path?

1. Completed road repairs should have rideability at least as good as, if not better than, the pavement prior to the repairs. A driver may be able to see a road repair, but in the case of a quality repair, they should not be able to “feel” it in driving normally down the road.

2. Do not place overlays with feathered edges on roads of any classification. Overlays should be placed by first removing the existing pavement to the desired depth by grinding, and then placing the pavement flush with the adjacent surfaces.

**NOT ACCEPTABLE**

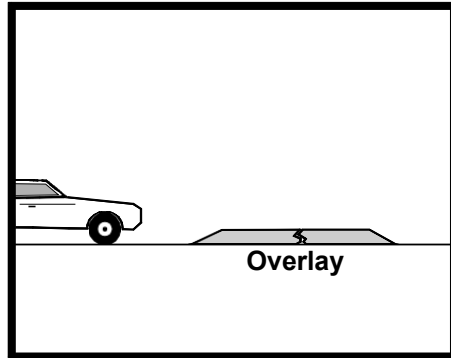

**ACCEPTABLE**

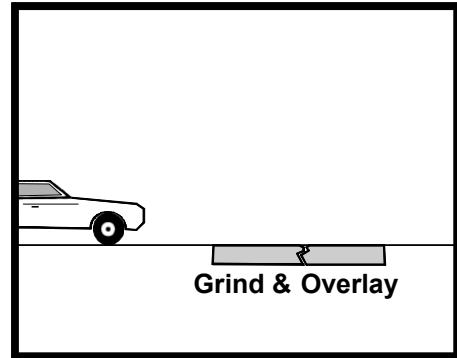

3. Surface tolerances for road repairs should meet the standard for new construction. That is, the finished surface of the road repair, when tested with a ten (10) foot straightedge parallel to the centerline or perpendicular across joints, will show variations measured from the testing face of the straightedge to the surface of the road repair which do not exceed one-quarter (1/4) inch.

**NOT ACCEPTABLE**

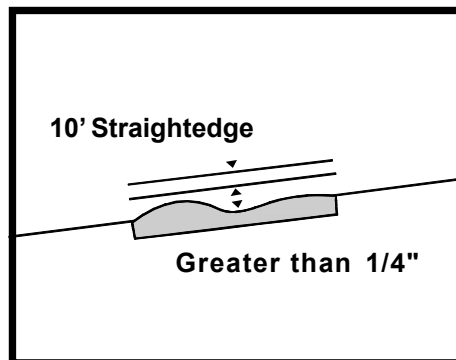

**ACCEPTABLE**

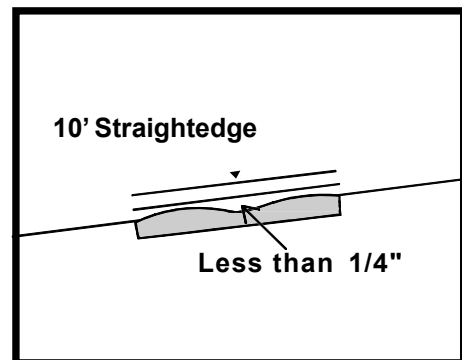

**12.4.4 Pavement Management**

Is the repair consistent with the long-term pavement management strategy for the particular road?

1. Road repairs should leave a pavement in a condition at least as good as, if not better than, the condition prior to the repairs.

2. In most cases, and particularly in the cases of extensive excavation and repairs, it is desirable to survey the existing pavement condition with a representative of the County prior to the work. After completion of the work, survey the pavement condition again to verify that the pavement condition has been maintained or improved.
  - a. In the case of minor repairs, these pavement surveys can be made by visual observation.
  - b. However, in the case of major projects that involve excessive haul of materials or unusually heavy construction equipment or activity, non-destructive testing of the pavement condition before and after construction may be required.
3. Consideration of pavement management issues may also identify opportunities for joint efforts between the utilities and the County.

For example, if the repair of a utility line requires an overlay on half of a road, and that the condition of the remaining half of the road warrants an overlay, the County may decide to overlay the entire road, with County and the utility splitting the cost of the overlay. In such a case, the utility may be able to save the cost of grinding half the road. Coordination for these types of cooperative repairs should occur as far in advance of actual construction as possible.

- a. Transverse patches on arterial and collector roads shall be overlaid across the entire road width for a distance of two (2) feet minimum on all sides of the trench.

**NOT ACCEPTABLE**

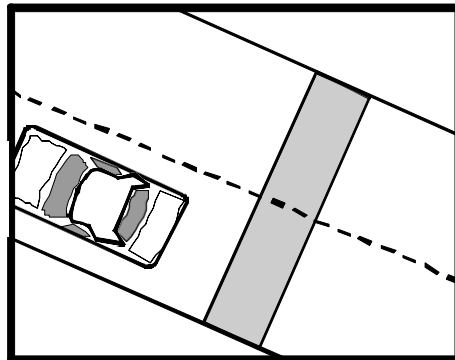

**ACCEPTABLE**

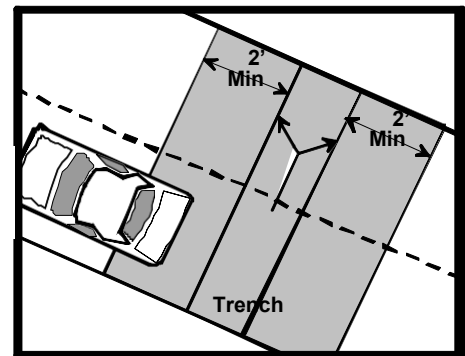



- b. Do not allow the edges of patches to fall in existing wheel paths. The edges of patches parallel to the direction of traffic shall be limited to the boundaries of lanes or to the centerline of travel lanes.

**NOT ACCEPTABLE**

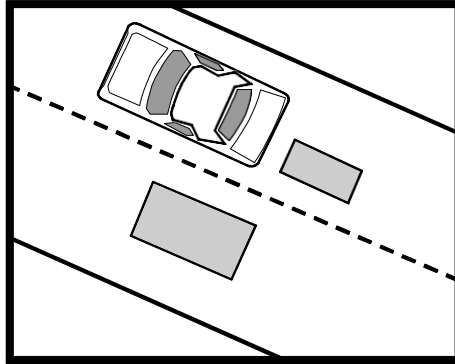

**ACCEPTABLE**

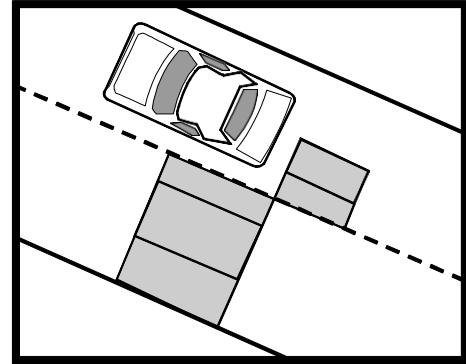

- c. Patches should have a smooth longitudinal grade consistent with the existing roadway. Patches should also have a cross slope or cross section consistent with the design of the existing roadway.

**NOT ACCEPTABLE**

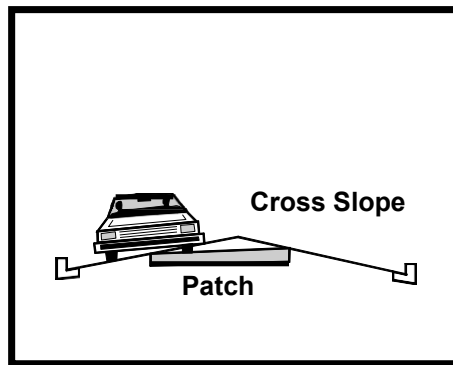

**ACCEPTABLE**

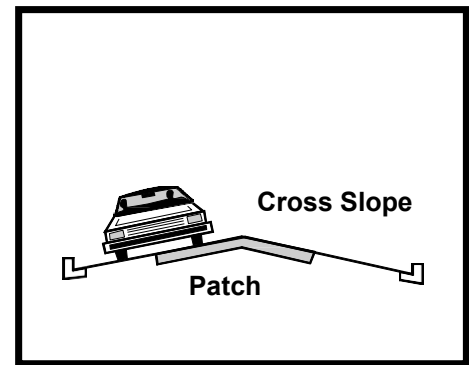

### 12.4.5 Future Maintenance

Will the repair pose any future maintenance problems or make future maintenance more difficult?

- 1. Excavations and road repairs, even when well constructed, shorten a pavement's life. Several types of road distress, settlement, alligator cracking, and potholes, often show up around patches. Quality road repairs should attempt to reduce the occurrence of these types of distress.

2. Avoid weakening or destroying the existing pavement around an excavation with heavy construction equipment, stockpiling or delivery of materials, etc. When damage does occur, remove the damaged pavement, extending the limits of the road repair, before replacing the pavement. Remember, no stockpiling of backfill or road building materials is permitted on the pavement.
  - a. When the proposed excavation falls within ten feet of a section of failed pavement, the failed area shall be removed to sound pavement and patched. Scarring, gouging, or other damaged pavement adjacent to a patch shall be removed and the pavement repaired.

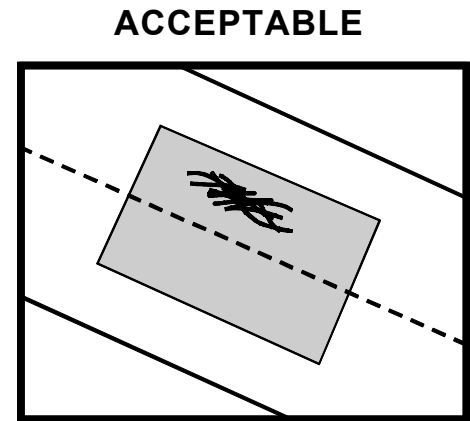
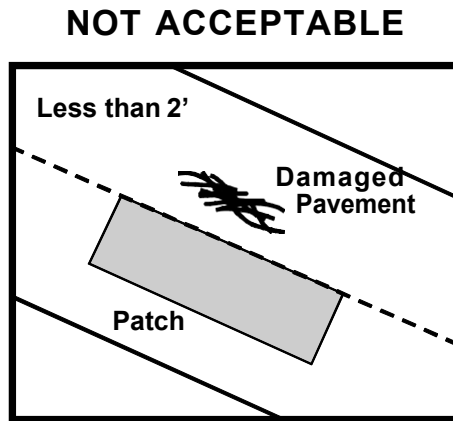

- b. In the case of older pavement where the likelihood of cracking and potholes next to the patch is greater, it may be necessary to extend the “shoulders” of the pavement beyond the two-foot minimum, and reinforce this area with a geotextile. “T” cutting is required for all repairs.

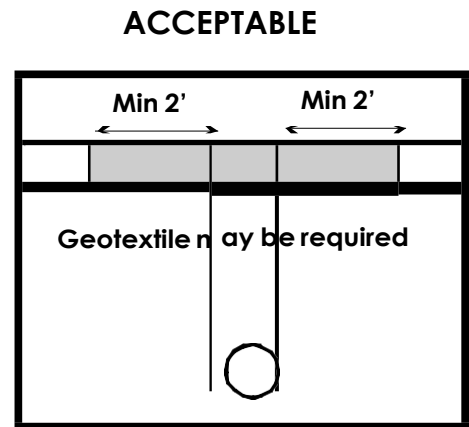
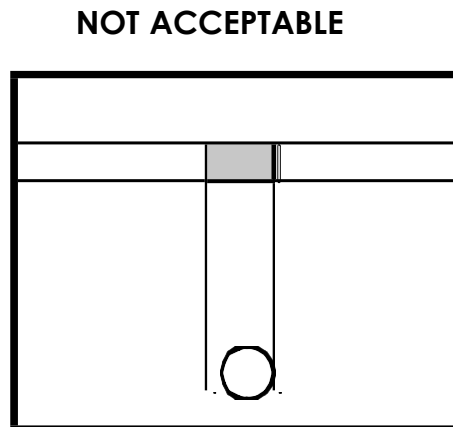

- c. For patches in asphalt, a tack coat shall be applied to all edges of the existing asphalt before placing the new pavement. After placing the new asphalt, all seams (joints) between the new and existing pavements shall be sealed with an asphalt tack coat or rubberized crack seal material.

- d. Avoid frequent changes in width of patches to simply removal of adjacent pavement failures in the future.

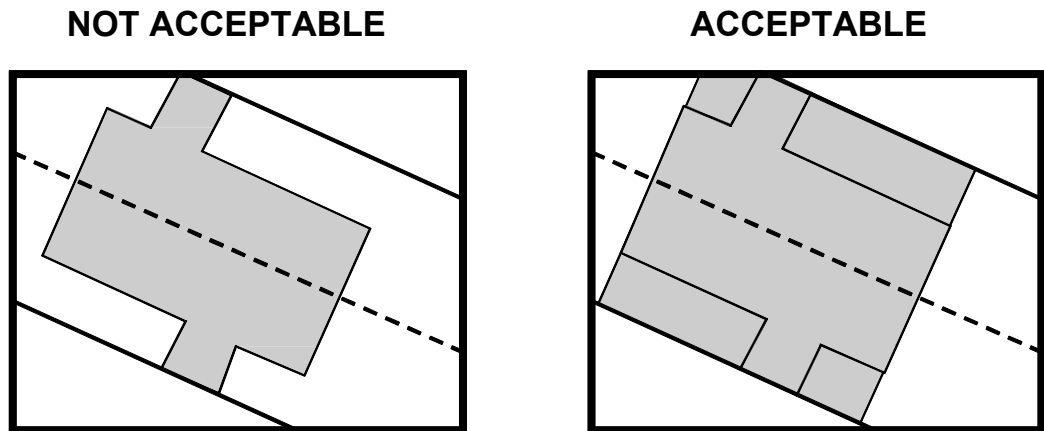

## 12.5 TESTING

### 12.5.1 Description

The contractor is required to provide material testing for each phase of the work at no cost to the County. The independent Geotechnical Testing Firm chosen to perform this work for the Contractor must be qualified and identified on the Permit application.

### 12.5.2 Testing Frequencies

1. The number of density tests required may be increased if directed by the Engineer. The costs of any testing, as required, shall be borne by the Contractor. Proctors shall be determined prior to backfilling. Independent lab results shall be faxed to the County as soon as possible. The horizontal frequencies of density tests are as follows:
  - a. Utility Mains - One test per 100 linear feet per lift.
  - b. Service Lines - One test per each service per lift.
  - c. Manholes and valve boxes per each lift.
2. Following are the minimum number of tests required for each construction activity. These tests must be submitted to the Engineer on a daily basis as acquired and shall be hand delivered or faxed to the County.
  - a. Native or imported backfill - One (1) test for every two (2) vertical feet and every one hundred (100) feet horizontally, or some fraction thereof with at least one (1) test per each lift.
  - b. Flowable-fill – Testing may be required at the discretion of the Engineer.
  - c. Concrete pavement, curbs, gutters and sidewalks – Testing to be conducted for every 100 cubic yards or portion thereof, with a minimum of one. The types of testing required shall be as prescribed by the County.

- d. Asphalt Pavement
  - 1) Asphalt content – One test per 500 tons or fraction thereof of mix produced, minimum of one test per job.
  - 2) Gradation – Aggregate: one test per 500 tons or fraction thereof of mix produced, minimum of one test per job.
  - 3) In-place density – One test per 500 tons or fraction thereof of mix placed, minimum of one test per job.
- e. Aggregate base course materials – One test per 400 lane feet. No less than two (2) tests per excavation.

## **12.6 INSPECTION**

All construction work within the public rights-of-way shall be subject to inspection by the Engineer and certain types of work may have continuous inspection. It shall be the responsibility of the Contractor to provide safe access for the inspector to perform the required inspections.

It shall be the responsibility of the person performing the work authorized by the Permit to notify the Engineer when the work is ready for inspection. The Engineer requires that every request for inspection is to be received at least twenty-four (24) hours before such inspection is desired. Such requests may be in writing or by telephoning or faxing the Engineer.

The Engineer may make or require other inspections of any work as deemed necessary to ascertain compliance with the provisions of these Standards. Any work performed without the required inspections shall be subject to removal and replacement at the Contractor's expense, regardless of the quality of the work.

Where large scale projects exceed the ability of the County to provide inspection, the Contractor or utility company will incur the cost of a private inspection firm. This inspection firm will be mutually agreed upon by the Permit applicant and the County prior to issuance of the Permit.

# APPENDIX A – DEFINITIONS AND ABBREVIATIONS

## A.1 GENERAL DEFINITIONS AND ABBREVIATIONS

Where the following words, phrases, or abbreviations appear in these specifications they shall have the following meanings:

- **AASHTO** – American Association of State Highway and Transportation Officials.
- **ABC** – Aggregate Base Course.
- **Access Management Plan** – A plan adopted by Larimer County defining access locations and requirements based on the traffic impact study evaluation of existing and proposed traffic, access points, and intersections. An access management plan supplements the Local Entity's Transportation Master Plan, specifically adopted to regulate access on specific streets.
- **ACI** – American Concrete Institute.
- **ADA** - Americans with Disabilities Act
- **AISC** – American Institute of Steel Construction.
- **ANSI** – American National Standards Institute.
- **Applicant** – The person or designated agent providing pertinent information for preparation of permit, TIS, etc. This is often the Developer.
- **APWA** – American Public Works Association.
- **ASA** – American Standards Association.
- **"As-Built" or Record Drawings** - Set of original plans, with information superimposed upon them, showing any additions, deletions, changes, etc.
- **ASTM** – American Society for Testing and Materials.
- **ATSSA** – American Traffic Safety Services Association.
- **BCC** - Board of County Commissioners of Larimer County, Colorado
- **Bridge** – Any structure conveying a roadway or path over a body of water or other feature. Bridges shall be designed to carry a varying combination of loading, including vehicular, bicycle, and/or pedestrian traffic.
- **Calendar Day** – Each and every day shown on the calendar, beginning and ending at midnight.
- **Capital Expansion Fee (CEF) Program** – A program that has been established by Larimer County for the purpose of funding certain transportation improvements. The roads funded by a CEF Program primarily serve the overall transportation system, not just a single development.
- **CDOT** – Colorado Department of Transportation.
- **City** - Any incorporated area within Larimer County, Colorado
- **CMP** – Corrugated Metal Pipe.

- **Code** – The latest official adopted ordinances, policies, codes, and/or regulations of Larimer County otherwise referred to as the Larimer County Land Use Code.
- **Construction Plans** - Detailed and working plans including plan and profile, details, notes and any other information necessary for complete construction of the required improvements.
- **Consultant Engineer** – A Colorado licensed professional engineer working on behalf of the Developer.
- **Continuity** – The continuous length of a roadway segment that is uninterrupted by 90 degree turns or controlled intersections.
- **Contractor** – The person, firm, or organization to whom a construction contract is awarded by the Developer, or who has been issued a right-of-way work permit by Larimer County. Agents, employees, workers, or designers employed by the Contractor are also bound by the terms of the contract or permit.
- **Corner Sight Distance** – The distance necessary for the driver of a motor vehicle stopped at a stop sign on a Minor Street or driveway to see approaching vehicles, pedestrians, and bicyclists along the intersecting major street and have sufficient space to make any allowed move to cross the Major Street or merge with traffic on the Major Street without causing vehicles, pedestrians, or bicyclists traveling at or near the design speed on the major street to slow down. The controlling distance for design is the longest distance, generally the distance necessary to merge with traffic.
- **County** - County of Larimer, State of Colorado.
- **Cross Slope** – Slope of the pavement surface, excluding gutter, measured perpendicular to the street centerline.
- **Days** – Intended as calendar days and not working days unless stipulated as working days.
- **DCP** – Development Construction Permit.
- **Design Speed** – The speed determined for design which takes into account the physical features of a street influencing vehicle operation; the maximum safe speed maintainable on a specified section of street when conditions permit design features to govern. Design speed is 5 to 10 mph higher than the posted speed limit to provide a factor of safety and allow for other conditions or uses of the street that may affect vehicle operation.
- **Designer** – The person or persons responsible for the creation and submission of contract documents or construction plans for the purpose of one-time construction of a facility. This person shall be a Colorado licensed professional engineer.
- **Developer** – The private party or parties desiring to construct a public or private improvement within Larimer County rights-of-way or easements, securing all required approvals and permits from the County, and assuming full and complete responsibility for the project.
- **Development** – Construction of improvements on land that is essentially vacant.
- **Development Agreement (DA)** – The contract between Larimer County and the Developer that defines public improvement requirements, costs, and other related public improvement issues.

- **Development Construction Meeting** – A meeting between the Designer and assigned agents and the Engineer to review proposed work necessary to construct the project, **prior** to proceeding with the work. A meeting may be required for each project, at the Engineer’s discretion.
- **Development Construction Permit** – Permit to construct public or private improvements for a project or within an unimproved right-of-way, obtained by application to the Local Entity.
- **Director of Public Works (DPW)** – The Larimer County Director of Public Works who oversees the Engineering Department.
- **Driveway** – A private access with 20 trips per day or less onto a public or private roadway.
- **Driveway Approach** – The portion of the driveway lying in the public right-of-way or public access easement between the roadway of a public street and the right-of-way or public access easement line, for the full width of the access, including both apron and side slopes.
- **Easement** – The property right of the Local Entity to use lands owned in fee by a private party for the purposes of maintenance, access, drainage, or other use, as specified on a plat or deed of dedication.
- **Engineer** - The County Engineer, Larimer County, Colorado, or their authorized representative, acting on behalf of the County.
- **FEMA** – Federal Emergency Management Agency.
- **FHWA** – Federal Highway Administration, Department of Transportation.
- **Final Acceptance** – The written notification from the County, after the County finds the Warranty Period to be satisfactorily completed, that all public improvements are free of defects and the County releases the Developer from future maintenance obligations.
- **FIRM** – Flood Insurance Rate Map.
- **Frontage** – The distance along the road right-of-way line of a single property or development within the property lines. Corner property at an intersection would have a separate frontage along each street.
- **GMA - Growth Management Area Overlay Zone District** – The areas defined in the Larimer County Master Plan as existing or future potential annexation areas. Wherever these standards associate “GMA” with a particular city, “GMA” refers to that town or city’s annexation areas.
- **HBP** – Hot Bituminous Pavement. Pavements constructed with a mix of aggregate and asphaltic/bituminous cement. (Similar acronyms used by other references may include: ACP – Asphalt Concrete Pavement, HAC – Hot Asphalt Concrete, HMA – Hot Mixed Asphalt, and similar variations.)
- **HMA** – Hot Mix Asphalt
- **IGA** - Inter-Governmental Agreement
- **Inspector** – An authorized representative of the Engineer, assigned to make inspections to assure work is completed in compliance with plans, standards and specifications.
- **Intersection Sight Distance** – Refer to Corner Sight Distance.

- **ITE** – Institute of Transportation Engineers.
- **Landscaping** – Materials including, without limitation, grass, ground cover, shrubs, vines, trees, and non-living materials, commonly used in landscape development, as well as attendant irrigation systems.
- **Lane Width** – The width of a travel lane measured from the centerline of the lane striping to the centerline of the parallel lane stripe.
- **Lift** – The maximum specified thickness of material that may be placed at one time.
- **Low Volume Access** – Access with daily traffic volumes between 21 and 99 vehicles.
- **May** – A permissive condition.
- **MUTCD** – Manual on Uniform Traffic Control Devices.
- **Opinion of Cost (Cost Estimate)** – Unit costs, based on those approved by Larimer County and assigned to materials and related quantities. The Opinion of Cost shall be broken down by Phase, when applicable, for each project and shall be submitted by the Designer at the time of first plan review by the Engineer.
- **OSHA** – Occupational Safety and Health Administration.
- **Owner's Engineer** - A registered engineer (State of Colorado) acting for the Owner or Developer.
- **P.C.** – Point of curvature.
- **Permittee** – The holder of a valid permit issued in accordance with these Standards or other County related process.
- **Phasing Plan** – A plan that defines improvements to be completed in specified parts over a defined sequence.
- **P.I.** – Point of intersection.
- **Plans** – Construction plans signed by the County depicting public improvements to be constructed for the project.
- **Professional Engineer (P.E.)** – A Colorado licensed professional engineer.
- **Professional Land Surveyor (P.L.S.)** – A Colorado licensed land surveyor.
- **Project** – The public or private improvement(s) designated in the approved plans, which are to be constructed in conformance with these Standards. The term “Project” includes any and all public or private improvement projects for or within the Local Entity, whether development projects, private utility projects, or capital improvement projects.
- **Proposed Roadway Improvements** – Those roadway improvements deemed necessary due to the impact of the project development.
- **P.T.** – Point of tangency.
- **Public Improvement Construction Plans** – Detailed and working plans including plan and profile, details, notes and any other information necessary for complete construction of the required improvements. Also refer to Utility Plans.
- **Public Improvements** – Those public-type facilities to include: pavement, curb and gutter, sidewalk, pedestrian/bike/equestrian paths, storm drain facilities with related appurtenances, culverts, channels, bridges, water distribution or transmission facilities



with related appurtenances, sanitary sewer collection facilities with related appurtenances, water and waste water treatment facilities, pavement markings, signage and striping, traffic signals and related appurtenances, erosion control and right-of-way grading, or earth excavation processes integral to construction of other public improvements listed herein.

- **Right-of-way (ROW)** – (Also “public right-of-way.”) A public street, way, alley, sidewalk, or easement.
- **Road or Street** - A general term denoting a public or private way used for access to two or more lots, parcels, or tracts of land, including the entire area within the right-of-way and/or access easement.
- **Scoping Meeting** – A required meeting for the Applicant and Applicant’s traffic engineer to review all the requirements for a Transportation Impact Study.
- **Shall** – A mandatory condition.
- **Should** – An advisory condition, recommended, but not required.
- **Stopping Sight Distance** – The distance required by the driver of a vehicle traveling at the design speed to bring the vehicle to a stop after an object on the road becomes visible. This distance is measured from the driver’s eye, 3.5 feet above the pavement to the top of an object 6 inches high on the pavement anywhere on the roadway.
- **Substantial Completion** - That degree of completion of the project or a portion of the project, sufficient to provide the County the use of the project or a defined portion of the project for the purposes for which it was intended.
- **TIS** - Transportation Impact Study, as described in Appendix F.
- **USGS** – United States Geological Survey.
- **Variance** – A deviation from these Standards that has been duly and properly approved by the County.
- **Wheel Path** – The 3-foot wide wheel traveled portion located on both sides of the travel lane and starting 2 feet from the center of the travel lane.
- **Working Day** – 7 a.m. to 6 p.m., Monday through Friday, excluding any holidays observed by the Local Entity.

## **A.2 DEFINITION OF ROAD FUNCTIONAL CATEGORY**

All roads are divided into functional classification categories for planning purposes and are defined in the Larimer County Transportation Plan.

## **A.3 TERRAIN CLASSIFICATION**

For the purposes of this manual, the terrain in Larimer County is divided into two categories:

- A. **FLAT OR ROLLING TERRAIN** - Average cross slope less than 15% and the ridges and draws are not steep and well defined.
- B. **MOUNTAINOUS TERRAIN** - Average cross slope greater than 15% and the ridges and draws are steep and well defined.

## APPENDIX B – REFERENCES AND RESOURCE STANDARDS

The following Standards (the latest editions unless otherwise stated) may be used as reference material when certain design or construction methods and materials are not specifically addressed in these Standards and require approval of the Engineer.

<b>PUBLICATION</b>	<b>AGENCY</b>
Americans with Disabilities Act	DOJ/EEOC
Bridge Design Manual	CDOT
Bridge Detail Manual	CDOT
Construction Manual	CDOT
CADD Manual	CDOT
Design Guide	CDOT
Drainage Design Manual	CDOT
Field Materials Manual	CDOT
Highway Capacity Manual	ITE
LRFD Bridge Design Specifications	AASHTO
Larimer County Land Use Code	LC Planning
Manual on Uniform Traffic Control Devices	FHWA / US DOT
NCHRP Report 279, Intersection Channelization Guide	NCHRP
Pavement Design Manual	CDOT
Policy on Geometric Design of Highways & Streets	AASHTO
Roadside Design Guide	AASHTO
Roundabouts, an Informational Guide	FHWA
Standard Plans (M & S Standards)	CDOT
Standard Specifications for Highway Bridges	AASHTO
Standard Specifications for Road & Bridge Construction	CDOT
Standard Specifications for Transportation Materials and Methods of Sampling and Testing	AASHTO
State Highway Access Code	CDOT
Storm Water Design Standards	LC Engineering
Survey Manual	CDOT
Trip Generation Manual	ITE

## **APPENDIX C – STANDARD DRAWINGS**

- DRAWING 1    RURAL ARTERIAL ROAD - TYPICAL SECTION**
- DRAWING 2    RURAL MAJOR COLLECTOR ROAD - TYPICAL SECTION**
- DRAWING 3    RURAL MINOR COLLECTOR ROAD - TYPICAL SECTION**
- DRAWING 4    RURAL LOCAL ROAD - TYPICAL SECTION**
- DRAWING 5    RURAL LOCAL LOW VOLUME ROAD - TYPICAL SECTION**
- DRAWING 6    CUL – DE –SAC DETAIL**
- DRAWING 7    TYPICAL ACCESS DETAIL**
- DRAWING 8    STREET NAME SIGN MOUNTING AND LOCATION DETAIL**
- DRAWING 9    LARIMER COUNTY STREET NAME SIGNS DETAIL**
- DRAWING 10    GENERAL TRAFFIC SIGN LOCATION DETAIL**
- DRAWING 11    CULVERT DETAIL**

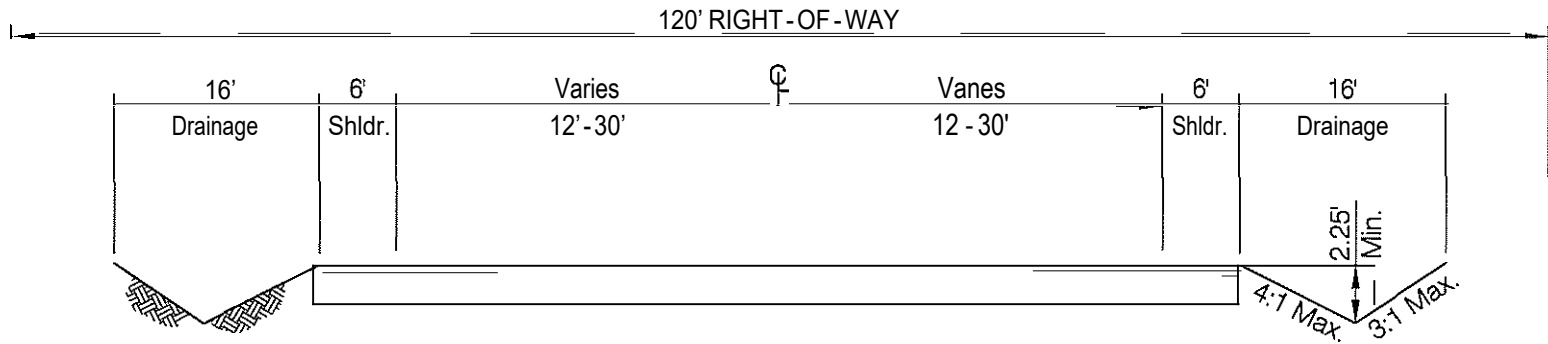

- Shoulders shall be 6' wide
- 12' Wide Travel Lanes
- Number of lanes vary (2-5 Lanes)

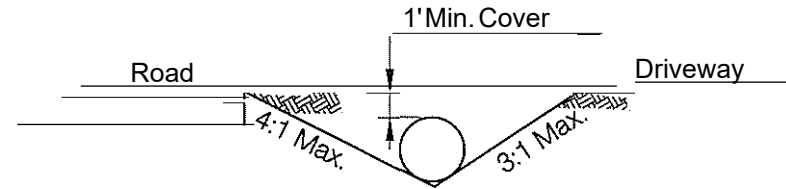

+e If a culvert larger than 15" is required, the borrow ditch will need to be deeper than the minimum 2.25'.

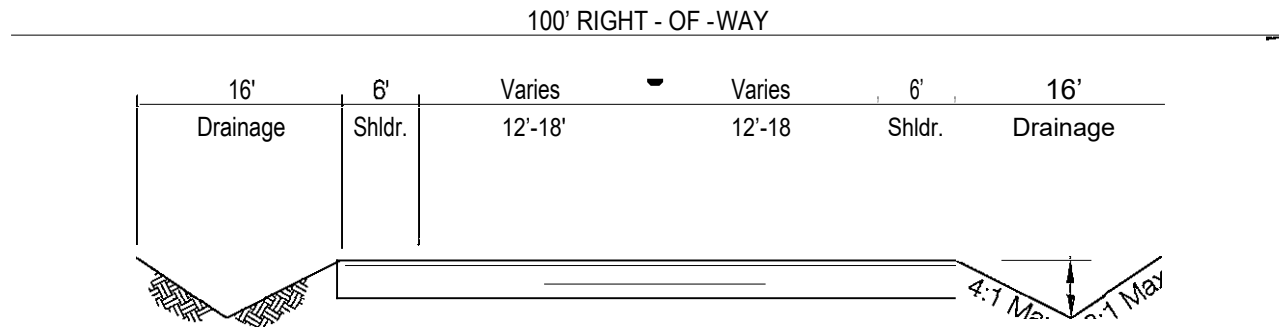

- Shoulders shall be 6' wide
- 12' Wide Travel Lanes
- Number of lanes vary (2—3 Lanes)

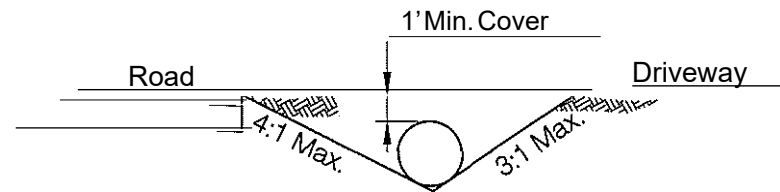

++ If a culvert larger than 15' is required, the borrow ditch will need to be deeper than the minimum 2.25'.

REVISION NO:  
DATE: 08/16/06

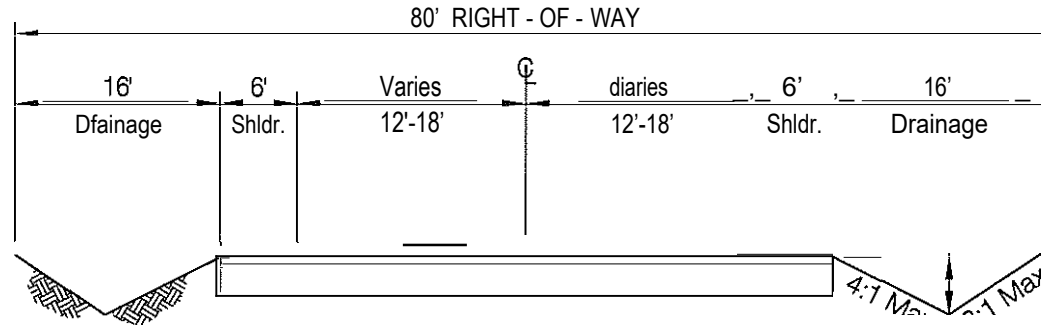

- Shoulders shall be 6' wide
- 12' Wide Travel Lanes
- Number of lanes vary (2-3 Lanes)

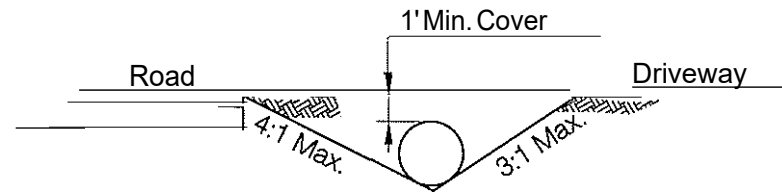

+6 If a culvert larger than 15" is required, the borrow ditch will need to be deeper than the minimum 2.25'.

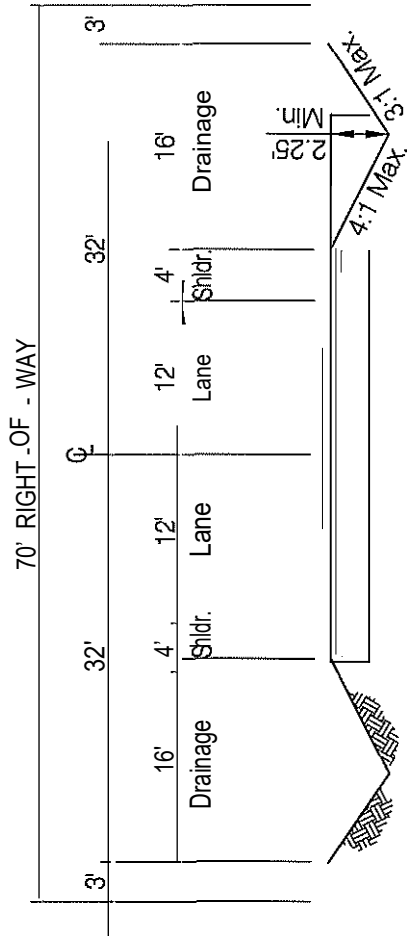

- Shoulders shall be 4' wide
- 12' Wide Travel Lanes
- This Local Road Section typically applies for 100 or more vehicle trips per day.

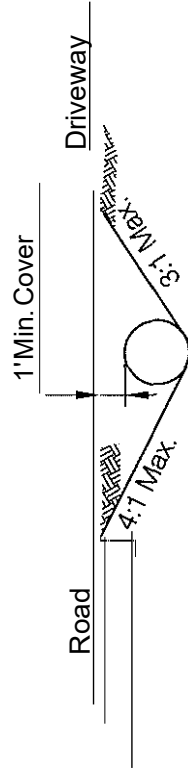

e+ If a culvert larger than 15' is required, the borrow ditch will need to be deeper than the minimum 2.25'.

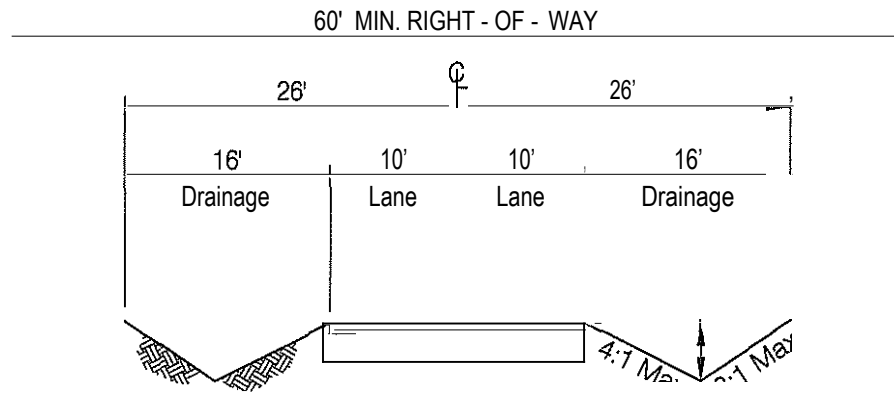

- 10' Wide Travel Lanes

The use of this roadway section may only be used when approved by the Engineer. Typically, it will be applied for 21 to 99 vehicle trips per day and only if future road connectivity is not feasible.

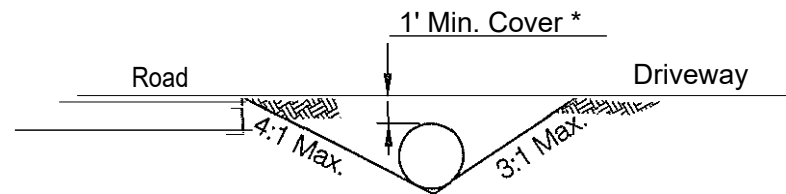

e+ If a culvert larger than 15" is required, the borrow ditch will need to be deeper than the minimum 2.25'.



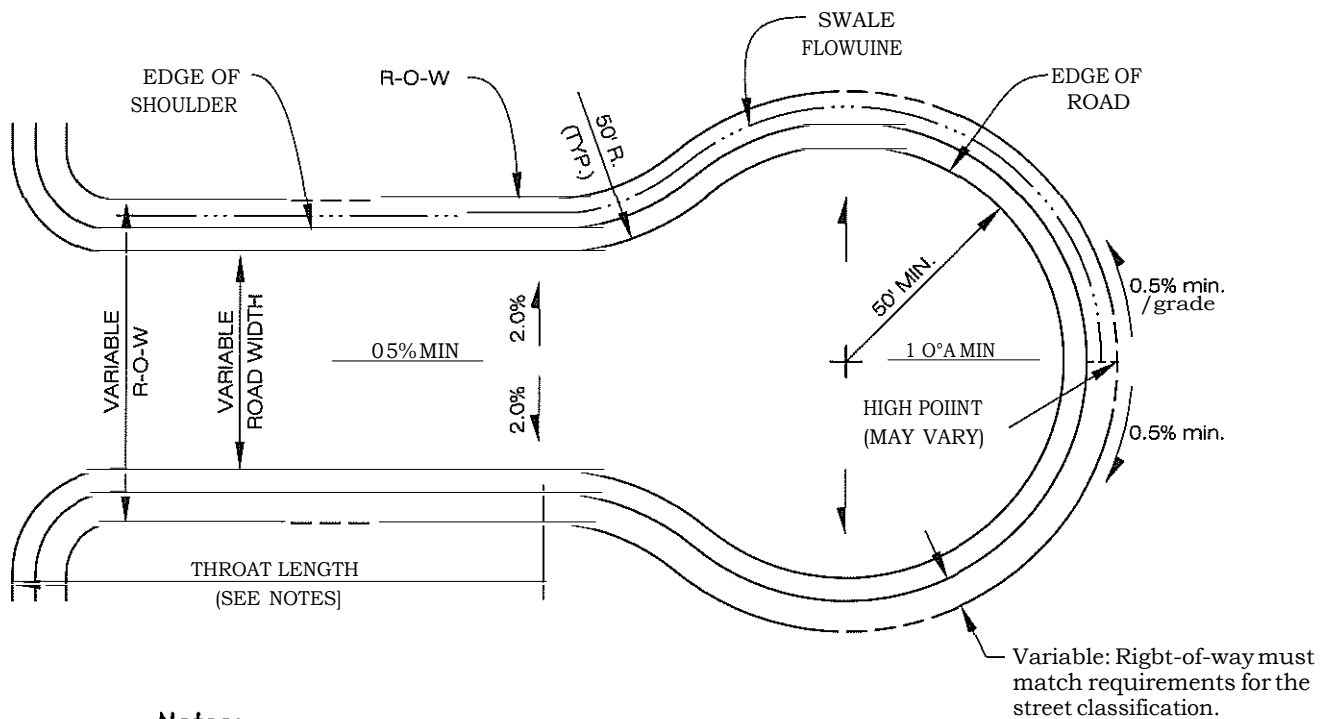

**Notes:**

- Cut-de-sae may be asymmetrical.
- Maximum length of cut-de-sae is 660 ft, Longer cut-de-sacs require second point of access.
- All cut-de-sacs must meet local fire authority requirements. More stringent criteria than that stated above may apply.
- Minimum throat length shall meet the minimum tangent length requirements given in Section 4.\*.2.1 .b. .

**CUL – DE - SAC DETAIL**

LARIMER COUNTY  
RURAL AREA  
ROAD STANDARDS

5 STANDARD  
DRAWING

REVISION NO:  
DATE: 08/t6/06

DRAWING  
6

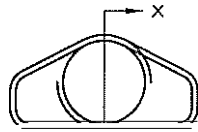

F.E.S. END VIEW

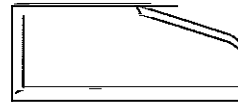

SECTION X-X

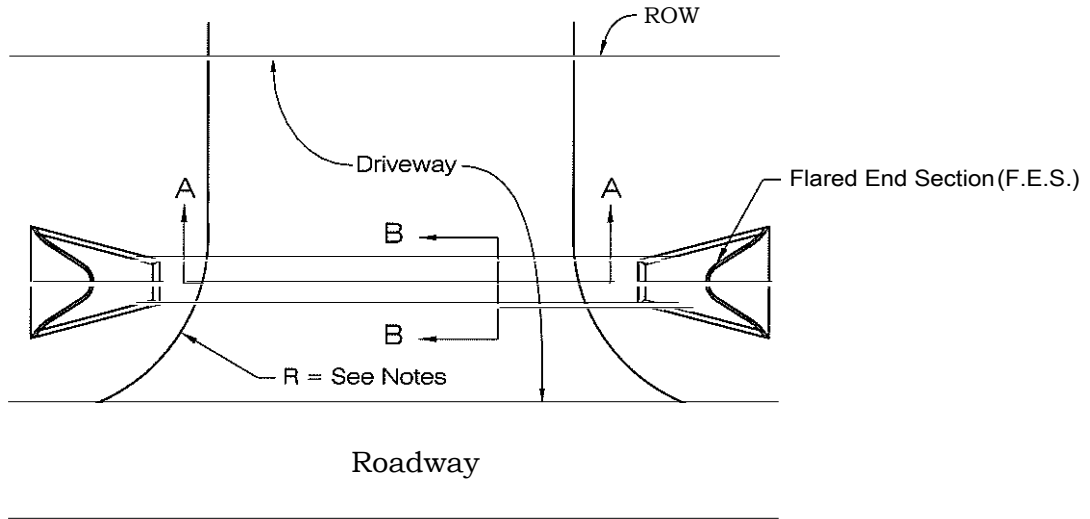

PLANT VIEW

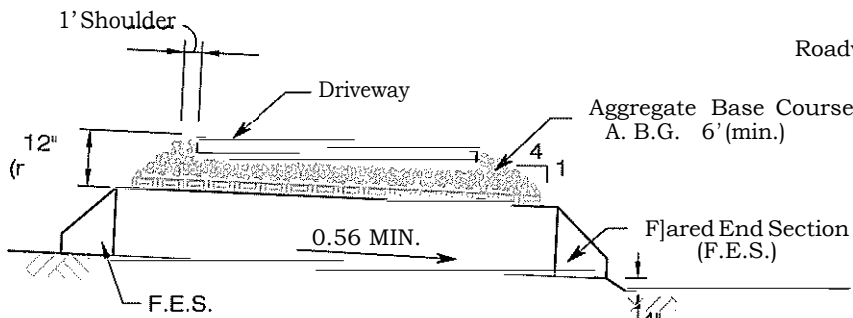

SECTION A-A

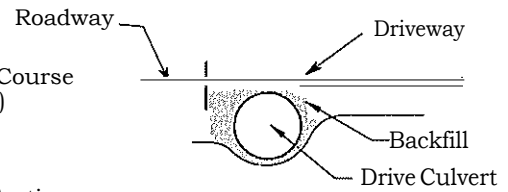

SECTION B-B

Notes:

- For single family residential access onto local subdivision roads, a radius of 15 feet is recommended.
- For single family residential access onto all other roads, a minimum radius of 15 feet is required.
- For commercial / industrial accesses, the maximum radius is 50 feet.
- See Culvert Detail Drawing 11 for required pipe size and material.

**TYPICAL ACCESS DETAIL**

LARIMER COUNTY  
RURAL AREA  
ROAD STANDARDS

STANDARD  
DRAWING

REVISION NO:  
DATE: 08/16/06

DRAWING

7

Panels bolted together at each end be' from end of panel

SAMPLE AVE

Panels mounted back to back bolted directly to post at center of panel

1" / 4" Galvanized or Aluminum Square Tube Post

Post fastened to anchor with 2 bolts at 90° angle from each other

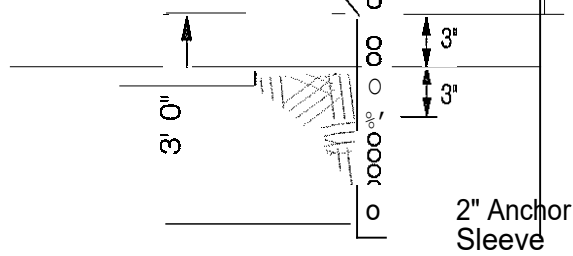

N1N1NMUMCRTERAF0RS0UARETU8EP00T	
Anchor Sleeve'	Post 8ze'
2'x2'x3'-0'	1 3/4' x 1 3/4' x 10'-0

12 Gauge

Refer to Chapter 4 of the Larimer County Rural Area Road Standards.

County, State, or other Road

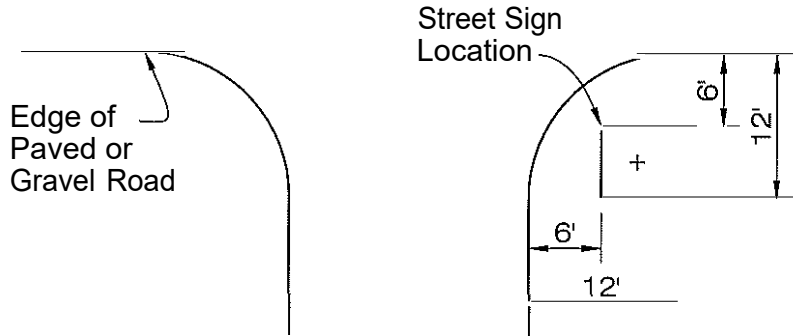

Location of signs must not obscure any potential traffic hazard. At any location where the typical placement of a sign interferes with a safe sight distance or the street name sign is not visible from the approaching roads, an alternate location must be found.

### STREET NAME SIGN MOUNTING AND LOCATION

LARIMER COUNTY  
RURAL AREA  
ROAD STANDARDS

STANDARD  
DRAWING

REVISION NO:  
DATE: 08/16/06

DRA G  
8

## LARIMER COUNTY STREET NAME SIGNS

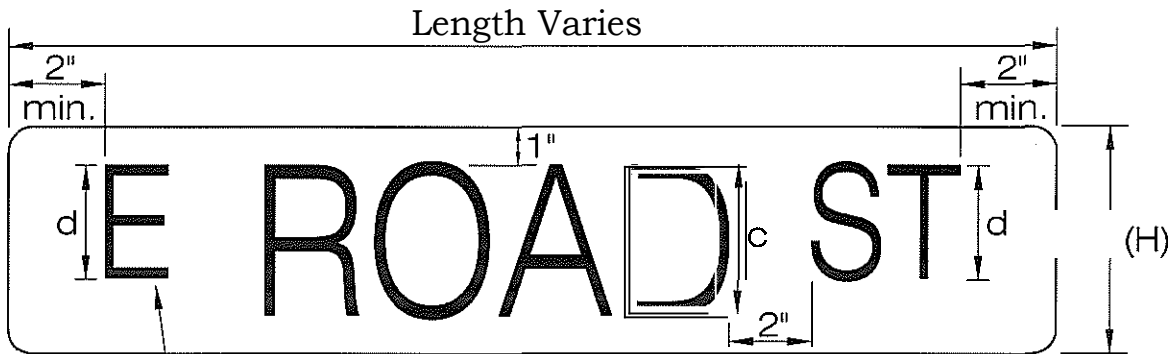

If Necessary

1. All letters and numbers must be retroreflective, white, FHWA Series "B".
2. All sign lettering and green background material must meet the current requirements for retroreflective sheeting in the current edition of the MUTCD.
3. Aluminum sign blank shall be 0.080 inch thickness with 3/4" corner radius.
  - SignBackgroundColor
  - All street name signs at intersections with Count Roads or State Highways shall have a green background.
  - All Subdivision roads in Ranges 68 & 69 shall have a green background.
  - All Internal Subdivision roads in Ranges West of Range 69 shall have a brown background.

POSTED SPEED LIMIT	MINIMUM LETTER SIZE		SUFFIX (d)	MINIMUM HEIGHT OF SIGN BLANK (H)
	UPPER CASE	LOWER CASE		
25 MPH OR LESS	4"	-	3"	6"; LENGTH VARIES
GREATER THAN 25 MPH	6"	4.5"	4"	8"; LENGTH VARIES
MULTI LANE ROAD GREATER THAN 40 MPH	8"	6"	5"	10"; LENGTH VARIES

## LARIMER COUNTY STREET NAME SIGNS

LARIMER COUNTY  
RURAL AREA  
ROAD STANDARDS

STANDARD  
DRAWING

REVISION NO:  
DATE: 08/16/06

DRAWING

9

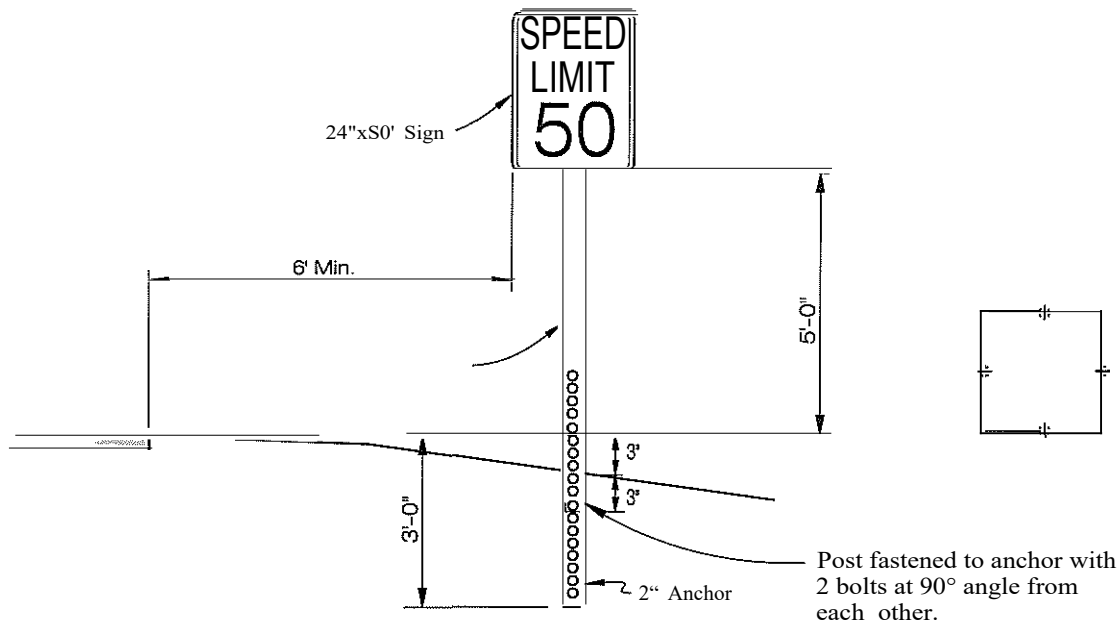

CRITERIA FOR SINGLE POST		
Max. sigs Panel	Base sleeve	Post size
9 sq. ft.	2.0'x2.0'x3'-0'	1 3/4' x 1 3/4' x 10'-0'

NOTES:

1. Attach the sign panels tightly to the post and use oversized washers to keep the sign from breaking loose from the post when hit by a vehicle.
2. Sign panels should be mounted a minimum of 5 feet above the pavement or road surface.
3. Signs larger than 9 sq. ft, require wind bracing and 2 or more posts.
4. Sleeve and post are square steel tube (perforated).
5. All signs small have at a minimum, high intensity retroreflective sheeting.
6. All signs shall conform to the Manual on Uniform Traffic Control Devices for shape, color and size.
7. All 'No Parking' signs shall be installed at 45° from Flow Line.

GENERAL TRAFFIC SIGN LOCATION DETAIL

LARIMER COUNTY  
RURAL AREA  
ROAD STANDARDS

STANDARD  
DRAWING

REVISION NO:  
DATE: 08/16/06

DRAWING  
10

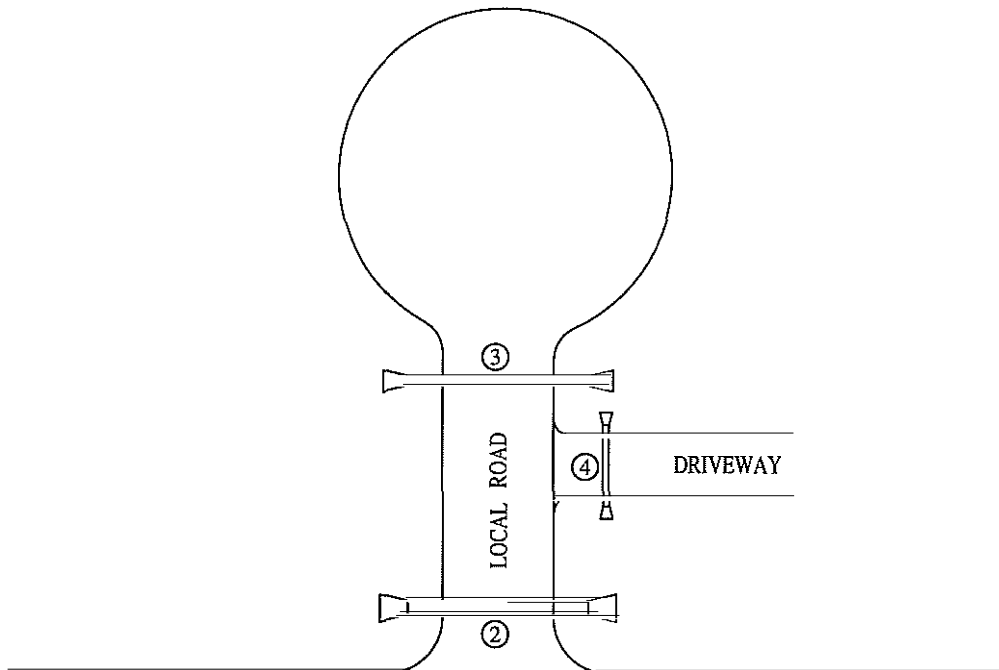

①

JOINTY ROAD



Culvert Crossing Type	Min. Size (in)	Material Allowed	End Treatment
1	24"	RCP	FES
2	18"	RCP	FES
3	18"	RCP CMP	FES
4	15"	RCP CMP HDPE	FES
5	15"	RCP CEP HDPE	FES

### CULVERT DETAIL

LARIMER COUNTY  
RURAL AREA  
ROAD STANDARDS

STANDARD  
DRAWING

VISION NO:

DATE: 04/09/07

DRA G

11

# APPENDIX D – CONSTRUCTION STANDARDS

## D.1 ROADS

### D.1.1 Scope

The purpose of this standard is to set forth the criteria to be used in the construction of all roads within Larimer County. Subject to the Larimer County revision of these standards, all road, bridge and related construction shall be performed in accordance with the latest edition of the Colorado Department of Transportation Standard Specifications for Road and Bridge Construction and the latest version of the Colorado Department of Transportation Standard Plans M&S Standards.

### D.1.2 General

1. **Variances from Standards.** These standards, the CDOT standards and construction plans are intended to supplement each other. In the event there is a conflict between the two, the standards shall govern except as supported by an approved variance request. If administrative changes are made after approval of the plans, the variance from these standards must be approved in writing by the Engineer. Work shall be completed according to the design approved by the Engineer. Written clarification shall be obtained from the Engineer for approval of omissions, conflicts or revisions prior to construction.
2. **Omissions.** Any work not specifically set forth in the construction plans or these standards, but which is necessary as determined by the Larimer County, shall be completed.
3. **Conformity of Work and Materials.** All work performed and all materials furnished shall be in conformity with the lines, grades, cross sections, dimensions and material requirements, including tolerances, shown on the plans or indicated in these criteria and the specifications. It shall be the responsibility of each individual contractor to keep the work area clean during the prosecution of the work.
4. **Utility Coordination.** Utility coordination is the responsibility of the Developer. Relocation of utilities which are in an existing public right-of-way or existing public easement, as determined by the Engineer, shall be done at the expense of the utility involved or the Developer.

### D.1.3 Regulations for Road Construction

1. **Authority of Engineer.** The Engineer is authorized to check all work performed in connection with road construction, including, but not limited to, clearing and grubbing, compaction of subgrade, placement of subbase, base and asphalt, forms, concrete work and materials to be used. The Engineer may be present on the site to advise contractors on these standards, and has authority to reject defective materials and workmanship, until any questions of issue can be resolved by the Engineer, and advise the Contractor in complying with construction plans and standards.

The Engineer shall, in no case, act as foreman or perform other duties for the Contractor, nor interfere with the management of the work done by the

Contractor. The presence or absence of the Engineer shall not relieve, in any degree, the responsibility or the obligation of the Developer, Contractor or the Consultant.

The Engineer shall, at all times, have reasonable and safe access to the work whenever it is in preparation or progress and the Contractor will provide proper facilities for such access and inspection. The Engineer has the authority to select locations for tests to be made and to require additional testing to be paid for by the Developer.

2. **Notice Before Beginning Work.** The Contractor shall notify the Engineer's office a minimum of 48 hours before beginning construction.
3. **Compaction in Utility Trenches, Culverts, etc.** Before road construction will be permitted, all utility trenches within the road right-of-way (including service lines) must be mechanically compacted to 95% of maximum density per AASHTO T 99 or AASHTO T180 or as specified in the soils report. All water and sewer services including water and sewer main stub-outs shall be installed prior to road construction. This compaction shall extend to the road right-of-way line as a minimum. Water settlement of trenches shall not be permitted.
4. **Construction Stakes.** The Developer shall provide all stakes necessary for curb, gutters, walks and structures and will furnish all necessary information relating to lines and grades. The Contractor shall be held responsible for the reasonable preservation of all such stakes.
5. **Work Zone Traffic Control.** Work zone traffic control devices shall be maintained in a safe operating condition at all times. The Contractor shall provide, for approval by the Engineer, a work zone traffic control plan, and shall comply with the current edition of The Manual on Uniform Traffic Control Devices (MUTCD). If the Engineer finds the construction area to be inadequately protected, the Engineer has the authority to stop work and direct that corrective measures be taken prior to proceeding with work.
6. **Preservation of Property.** Existing improvements, adjacent property, utilities, trees and plants that are not to be removed shall be protected from injury or damage resulting from the Contractor's operations.
7. **Timeliness of Repairs.** Repairs to all failed or unsatisfactory work shall be completed within 30 days after receipt of notice to repair from the Engineer unless otherwise approved by the Engineer.
8. **Protection of Utility Lines.** The Contractor shall at all times take proper precautions for the protection of utilities, the presence of which are known or can be determined by field locations of the utility companies.
9. **Protection of Public and Private Installations.** The Contractor shall at all times take proper precautions for the protection of driveway culverts, road intersection culverts or aprons, irrigation crossings, mailboxes, driveway approaches, and all other identifiable installations that may be encountered during construction. The Contractor shall be responsible for all expenses relating to damage to public and private installations.



## D.2 REVISIONS TO CDOT STANDARDS SPECIFICATIONS FOR ROAD AND BRIDGE CONSTRUCTION

SECTION	TITLE	Section
<b>D.1</b>	<b>Roads</b>	
Revision of Section 105	Control of Work.....	D.2.1
Revision of Section 106	Control of Material .....	D.2.2
Revision of Section 202	Removal of Asphalt (Planing).....	D.2.3
Revision of Section 203	Excavation and Embankment .....	D.2.4
Revision of Section 206	Excavation and Backfill for Structures.....	D.2.5
Revision of Section 217	Herbicide Treatment .....	D.2.6
Revision of Section 304	Aggregate Base Course.....	D.2.7
Revision of Section 304	Treated Aggregate Base Course .....	D.2.8
Revision of Section 308	Fly Ash Treated Subgrade .....	D.2.9
Revision of Section 401	Plant Mix Pavements – General (Non-Voids Acceptance) .....	D.2.10
Revision of Section 403	Hot Mix Asphalt .....	D.2.11
Revision of Section 412	Portland Cement Concrete Pavement.....	D.2.12
Revision of Section 601	Structural Concrete.....	D.2.13
Revision of Section 609	Curb and Gutter.....	D.2.14
Revision of Section 629	Survey Monumentation.....	D.2.15

## D.2.1 Revision of Section 105 – Control of Work

### REVISION OF SECTION 105 CONTROL OF WORK

**Subsection 105.03 shall include the following:**

Conformity to the Contract of all Hot Mix Asphalt, Item 403, will be determined by tests and evaluations of asphalt content, gradation and in-place density, and will be evaluated for acceptance, rejection.

**Delete subsection 105.04 and replaced with the following:**

105.04 Conformity to the Contract of Superpave Performance Graded Binders.

Superpave Performance Graded binders shall meet all requirements of Subsection 702.01.

The Contractor shall submit a Certificate of Compliance from the supplier for all binder delivered for use on the project. The Certificate of Compliance shall be prepared in accordance with subsection 106.12. A new Certificate of Compliance shall be prepared and submitted for each new lot or batch.

In addition to the Certificate of Compliance the contractor shall submit a “Bill of Lading” for each load of binder delivered for use on the project. Each “Bill of Lading” shall contain the lot or batch number identical to that on the Certificate of Compliance.

Binder that cannot be certified as complying with the requirements of Subsection 702.01 shall not be incorporated into the project.

Material which is obviously defective may be isolated and rejected without regard to sampling sequence or location within a lot or batch.

**Delete subsection 105.07 and replace with the following:**

**105.07 Conformity to Roadway Smoothness Criteria.** Roadway smoothness shall be tested as described below. Roadway smoothness testing will not be measured and paid for separately, but shall be included in the work.

All longitudinal and transverse pavement surfaces will be measured using a 10 foot straightedge. The Contractor shall furnish an approved 10 foot straightedge and depth gauge and provide an operator to aid the Engineer in testing the finished pavement surface. Areas to be measured shall be as directed by the Engineer. Areas showing high spots of more than 3/16 inch in 10 feet shall be marked and diamond ground until the high spot does not exceed 3/16 inch in 10 feet. Additional diamond grinding shall be performed as necessary to extend the area ground in each lateral direction so that the lateral limits of grinding are at a constant offset from and parallel to the nearest lane line or pavement edge,

and in each longitudinal direction so that the grinding begins and ends at lines normal to the pavement centerline within the ground area. All ground areas shall be neat rectangular areas of uniform surface.

Diamond grinding, including all necessary traffic control, shall be completed at the Contractor's expense.

On asphalt pavements, the diamond grinding shall not reduce planned pavement thickness by more than 0.3 inch and the entire ground area shall be covered with a fog seal coat when grinding is complete. On concrete pavements, the diamond grinding shall be completed prior to joint sealing and prior to determining pavement thickness in accordance with subsection 412.21. When longitudinal tining is required on concrete pavement, the diamond ground surface shall be grooved to restore the longitudinal texture, whenever the length of the ground area exceeds 45 feet.

If roadway smoothness exceeds the limits allowable for diamond grinding, corrective work on asphalt pavements shall consist of an approved overlay or removal and replacement. Corrective work on asphalt pavements shall conform to the following conditions:

- (a) Removal and replacement. The pavement in areas requiring corrective work shall be removed the full width of the lane and the full thickness of the course in accordance with Subsection 202.09 Removal of Asphalt Mat (Planing).

The removal area shall begin and end with a transverse butt joint, which shall be constructed with a transverse saw cut perpendicular to centerline. All replacement shall be made with approved hot mix asphalt mixtures that meet all contract requirements. Replacement material shall be placed in sufficient quantity so the finished surface will conform to grade and smoothness requirements. The corrective area shall be compacted to the specified density.

- (b) Overlay. The overlay shall cover the full width of the pavement including shoulders. The area overlaid shall begin and end with a transverse butt joint which shall be constructed with a transverse saw cut and asphalt removal. All material shall be approved hot mix asphalt mixtures that meet all contract requirements. The overlay shall be placed so the finished surface will conform to grade and smoothness requirements. The overlaid area shall be compacted to the specified density. The overlay thickness shall be equivalent to that of the final pass made in accordance with the plans and specifications.

If roadway smoothness exceeds the limits allowable for diamond grinding, corrective work on concrete pavements shall consist removal and replacement. Corrective work on concrete pavements shall conform to the following conditions:

Removal and Replacement. The pavement areas requiring corrective work shall be removed the full width of the lane and full length of the slab between horizontal control joints and shall be jointed in accordance with M-412-1

Regardless of the corrective method used, the final product shall provide a pavement surface equal to adjacent sections not requiring corrective work.

All corrective work, including all necessary traffic control, shall be completed at the Contractors expense.

In Subsection 105.08 delete the second paragraph and replace with the following

In case of discrepancy, the order of precedence is as follows:

- (a) Specifications
  - 1. Appendix D of Larimer County Specifications
  - 2. CDOT Standard Specifications
- (b) Details
  - 1. Appendix C Standard Drawings
  - 2. CDOT M & S Standards
- (c) Approved Development Construction Plans

## D.2.2 Revision of Section 106 – Control of Material

**REVISION OF SECTION 106  
CONTROL OF MATERIAL**

**Subsection 106.02 (b) shall include the following:**

The Contractor shall furnish evidence that Contractor source materials meet the contract specifications and shall pay for such tests as may be required to show compliance. All material shall be sampled and tested in accordance with the appropriate Colorado Department of Transportation or AASHTO procedures. Any materials lab doing work for the Contractor must be approved by the County before any testing is done.

The County is mandated by state statute (Section 35-5-102, CRS) to control the spread of the following noxious weeds:

Leafy spurge	<i>Euphorbia esula</i>
Canada thistle	<i>Cirsium arvense</i>
Musk thistle	<i>Carduus nutans</i>
Russian knapweed	<i>Centaurea repens</i>
Spotted knapweed	<i>Centaurea maculosa</i>
Diffuse knapweed	<i>Centaurea diffusa</i>
Yellow toadflax	<i>Linaria vulgaris</i>
Dalmation toadflax	<i>Linaria genistifolia</i>

Any source of imported embankment, topsoil, or gravel, except screened material, must be inspected and approved by the County Environmental Specialist, or designee, prior to incorporation into the project. If these materials are infested with these weeds, the Contractor must move to a different location within the area that is not infested or select another source altogether. The Contractor shall notify the County a minimum of two (2) days prior to moving any materials onto the project site in order to schedule this inspection. In the event the Contractor is unable to find a material source that is not infested, he shall be required to coordinate a treatment program with the Larimer County Weed District and the Engineer. The cost of complying with this requirement shall be included in the work.

D. Excavation, Removals And Embankment

1. Scope

The work covered by this subsection concerns the furnishing of all labor, equipment, supplies and materials necessary to perform clearing, grubbing, removal of objectionable materials from the right-of-way prior to grading operations, and placement of embankment to conformity with lines, grades and typical sections as shown on the plans or as staked.

2. Clearing and Grubbing

The natural ground surface shall be cleared of all vegetation such as trees, logs, upturned stumps, roots of downed trees, brush, grass, weeds and all other objectionable materials within the limits of the construction. All surface objects and all trees, stumps, roots and other protruding obstructions, not designated to remain, shall be cleared and/or grubbed, including mowing, as required, except undisturbed stumps and roots and nonperishable solid objects which will be a minimum of 2 ft below subgrade or slope of embankments. Trees which are to be removed shall be removed in such a manner as not to injure standing trees, plants, and improvements which are to remain.

3. Removal and Disposal of Materials

All materials removed shall be disposed of outside of the right-of-way. No accumulation of flammable material shall remain on or adjacent to the right-of-way. The roadway and related work areas shall be left with a neat and finished appearance.

### D.2.3 Revision of Section 202 – Removal of Asphalt

**REVISION OF SECTION 202  
REMOVAL OF ASPHALT (PLANING)**

**In subsection 202.09 delete the last paragraph and replace with the following:**

The longitudinal surface smoothness of the roadway shall conform to requirements of Subsection 105.07 – Conformity to Roadway Smoothness Criteria.

## D.2.4 Revision of Section 203 – Excavation and Embankment

### REVISION OF SECTION 203 EXCAVATION AND EMBANKMENT

**Subsection 203.03 (a), first paragraph, shall be deleted and replaced with the following:**

- (a) *Embankment Material.* Embankment material shall consist of approved material acquired from excavations, including Contractor's source, hauled and placed in embankments.

Contractor's source material shall have a minimum R-value of 15 ,and shall be equal to or greater than the design R-value required for the road when tested by the Hveem Stabilometer, have a maximum dry density of not less that 90 p.c.f., and must be stable when tested in accordance with Colorado Procedure L-3102. The Contractor shall furnish evidence that the material meets the requirements of this section and shall pay for such tests as may be required to show compliance. All materials shall be sampled and tested in accordance with appropriate CDOT or AASHTO procedures.

## D.2.5 Revision of Section 206 – Excavation and Embankment for Structures

### REVISION OF SECTION 206 EXCAVATION AND BACKFILL FOR STRUCTURES

**Subsection 206.02(a) shall include the following:**

Structure Backfill shall meet the requirements of Table 703-2, aggregate base course, Class 5 or Class 6, and shall be used in all locations where Class 1 or Class 2 Structure Backfill is specified.

## D.2.6 Revision of Section 217 – Herbicide Treatment

### REVISION OF SECTION 217 HERBICIDE TREATMENT

**Subsection 217.01 shall include the following:**

Herbicides shall be applied under all new paving and shall be applied to the surface directly beneath the surfacing material.

**In Subsection 217.02 delete the first sentence and replace with the following:**

The sterilization agent (herbicide) shall be a pre-emergent herbicide, soluble, dispersible or mixable in water and non-toxic to humans when applied per the manufacture's recommendations. The agent shall be active for one year after application.

### **D.2.7 Revision of Section 304 – Aggregate Base Course**

#### **REVISION OF SECTION 304 AGGREGATE BASE COURSE**

**Subsection 304.02 shall include the following:**

Materials for the base course shall be Aggregate Base Course (Class 5) as shown in subsection 703.03.

The Aggregate Base Course (Class 5) must meet the gradation requirements and have a resistance value of at least 72 when tested by the Hveem Stabilometer method. The Engineer may require the Contractor to submit test results from a certified materials lab to verify the material's conformance to the requirements of this section. Costs of any such tests shall be borne by the contractor.

### **D.2.8 Revision of Section 304 – Treated Aggregate Base Course**

#### **REVISION OF SECTION 304 TREATED AGGREGATE BASE COURSE**

**Subsection 304.02 shall include the following:**

Treated Aggregate Base Course (Class 5) (MGCL) shall meet the requirements of Section 304. Table 703-2 for Class 5 material shall be revised to allow 12 to 15 percent passing the #200 sieve.

**Subsection 304.06 shall include the following:**

Variation from the treated aggregate base course plan elevation specified shall not be more than 0.04 foot.

**Subsection 304.06(a) shall be added:**

Treated Aggregate Base Course (Class 5)(MGCL) shall be placed, mixed, shaped and compacted as described below:

Place and compact the full width and depth of Aggregate Base Course (Class 5) in accordance with Section 304. MGCL shall then be thoroughly mixed into the upper 4 inches of the road surface by scarifying and blading the upper four inches of aggregate base course material into approximately equal windrows on each side of the road. Wet, with water, both windrowed and remaining surface materials to approximately four- percent moisture, or as directed. Apply magnesium chloride in two equal sprayed applications of 0.25 gallon per square year each. After each application, used a motor grader (and additional water as necessary to prevent

segregation of the materials) to thoroughly process one half of the windrowed material to a uniform mixture. Place the processed mixture to grade and compact with a pneumatic tire roller, as specified in this section. Repeat this procedure for the material in the second windrow. Apply a final application of 0.10 gallon per square yard of magnesium chloride to the entire finished surface. Allow the magnesium chloride to soak in for thirty minutes or as needed to prevent surface displacement before final rolling. Compact the entire cross section with a steel drum roller in accordance with this section of the specifications. Do not allow traffic on the treated surface until approved.

## D.2.9 Revision of Section 308 – Fly Ash Treated Subgrade

### REVISION OF SECTION 308 FLY ASH TREATED SUBGRADE

**Section 308 is hereby added to the Standard Specifications for this project as follows:**

#### DESCRIPTION

**308.01** This work shall consist of treating the subgrade, existing subbase or existing base by pulverization, adding Class “C” fly ash, mixing and compacting of the mixed material to the required density. This work applies to natural ground or embankment and shall be constructed as specified herein and in conformity with the typical sections, lines, and grades as show on the plans or as established by the Engineer.

#### MATERIALS AND EQUIPMENT

- (a) *Fly Ash.* Fly Ash shall meet ASTM Specification 618, Section 3.2, when sampled and tested in accordance with Sections 4, 6, and 8, unless otherwise shown on the plans. Fly ash shall be of the class “C” designation containing a minimum of 25 percent CaO.

Fly ash shall be stored and handled in closed weatherproof containers until immediately before distribution on the road.

If stored in bins are used; they shall be completely enclosed. Materials in bags shall be stored in weatherproof buildings with adequate protection from ground dampness.

Fly ash shall be furnished in trucks, each truck shall have the weight of fly ash certified on public scales or the Contractor shall place a set of standard platform truck scales or hopper scales at a location approved by the Engineer.

- (b) *Water.* The water used in the stabilized mixture shall be clean, clear, and free of sewage, vegetable matter, oil, acid, and alkali. Water known to be potable may be used without testing. All other sources shall be tested in accordance with AASHTO T-26 and approved by the Engineer.
- (c) *Equipment.* The machinery, tools, and equipment necessary for proper prosecution of the work shall be on the project site and approved by the Engineer prior to the beginning of construction operations. All machinery, tools, and equipment used shall be



maintained in a satisfactory and workmanlike manner. Two self-propelled rotary type mixing machines, capable of performing the work as specified, shall be provided.

### CONSTRUCTION REQUIREMENTS

**308.3 General.** The Contractor shall construct a completed course of treated material which contains a uniform fly ash/soil mixture with no loose or segregated areas; has a uniform density and moisture content; is well bound for its full depth; and has a smooth surface suitable for placing subsequent courses. Variation from the subgrade plan elevations specified shall not be more than 0.08 foot. Where bituminous or concrete surfacing materials are to be placed directly on the subgrade, the subgrade plane shall not vary more than 0.04 foot. It shall be the responsibility of the Contractor to regulate the sequence of his work; to process a sufficient quantity of material to provide full depth treatment as shown on the plans; to use the proper amounts of fly ash; to maintain the work; and to rework the courses as necessary to meet the above requirements.

#### **308.4 Processing Materials.**

- (a) *Preparation of Subgrade.* Before construction operations begin, the subgrade shall be graded and shaped to enable the fly ash treatment of materials in place in conformance with the lines, grades, and thickness shown on the plans. Unsuitable soil or materials shall be removed and replaced with acceptable material.
- (b) *Fly Ash Application.* The fly ash shall be spread by an approved spreader at the rates shown on the plans or as directed by the Engineer. A motor grader shall not be used to spread the fly ash.

The fly ash shall be distributed at a uniform rate and in such a manner as to reduce the scattering of fly ash by wind to a minimum. Fly ash shall not be applied when wind conditions, in the opinion of the Engineer, are such that blowing fly ash becomes objectionable to traffic or adjacent property owners.

- (c) *Mixing.* The soil and fly ash shall be thoroughly mixed by use of at least two self-propelled rotary type mixing machines, capable of performing the work as specified and the mixing continued until, in the opinion of the Engineer, a homogenous, friable mixture of soil and fly ash is obtained, free from all clods or lumps. Water required to achieve the specified moisture content for the mixture should be added during final mixing.

If the soil/fly ash mixture contains clods, they shall be reduced in size by raking, blading, disking, harrowing, scarifying or the use of other approved pulverization methods so that when all nonslaking aggregates retained on the No. 4 sieve are removed, the remainder of the material shall meet the following requirements when tested at the field moisture condition by laboratory sieves:

Minimum Passing 1-3/4 inch sieve	100 percent
Minimum Passing No. 4 sieve	60 percent

During final mixing, water shall be added to the materials as directed by the Engineer, until the proper moisture content has been secured. Water shall be added through the pulverizing machine or other method acceptable to the Engineer to develop a uniform,

controlled rate addition of the needed moisture. Final moisture content of the mix, prior to compaction, shall not exceed the optimum moisture content of the mix by more than 2 percent nor by less than the optimum by more than 4 percent. Should the natural moisture content of the soil be above the specified range, aeration of the soil may be required prior to addition of the fly ash.

**308.5 Compaction.** Compaction of the mixture shall begin immediately after final mixing of the fly ash and be completed within one hour following addition of water to the fly ash. The material shall be sprinkled as necessary to maintain the optimum moisture. Compaction of the mixture shall begin at the bottom and shall continue until the entire depth of mixture is uniformly compacted to a specified density.

All non-uniform (too wet, too dry, or insufficiently treated) areas which appear shall be corrected immediately by scarifying the areas affected, adding or removing material as required, reshaping and recompacting. The surface of the course shall be maintained in a smooth condition, free from undulations and ruts, until other work is placed thereon or the work is accepted.

The stabilized section shall be compacted to the extent necessary to provide the density specified below:

For fly ash treated subgrade, existing subbase or maximum existing base that will receive subsequent subbase or base courses.	Not less than 95 percent dry density (ASTM D-698)
For fly ash treated subbase or base that will maximum receive surface course.	Not less than 96 percent Dry density (ASTM D-698)

In addition to the requirements specified for density, the full depth of the material shown on the plans shall be compacted to the extent necessary to remain firm and stable under construction equipment. After each section is completed, tests as necessary will be made by the Engineer.

If the material fails to meet the density requirements, the Engineer may require it to be reworked as necessary to meet those requirements or require the Contractor to change his construction methods to obtain required density on the next section. Throughout this entire operation the shape of the course shall be maintained by blading, and the surface, upon completion, shall be smooth and in conformity with the typical section shown on the plans and to established lines and grades. Blading should be terminated within two hours after blending of the fly ash. Should the material, due to any reason or cause, lose the required stability, density, and finish before the next course is placed or the work is accepted, it shall be reprocessed, recompacted and refinished at the sole expense of the Contract. Reprocessing shall follow the same pattern as the initial stabilization, including the addition of fly ash.

**308.6 Finishing and Curing.** After the final layer or course of the treated subgrade, subbase, or base has been compacted, it shall be brought to the required lines and grades in accordance with the typical sections.

The resulting base surface shall be thoroughly rolled with a pneumatic tire roller and “clipped”, “skinned”, or “tight bladed” by a motor grader to a depth of approximately ¼ inch, removing all

loosened stabilized material from the section. Recompaction of the loose material should not be attempted. The surface shall then be thoroughly compacted with the pneumatic roller, adding small increments of moisture as needed during rolling. If plus No. 4 aggregate is present in the mixture, one complete coverage of the section with the fat wheel roller shall be made immediately after the “clipping” operation. When directed by the Engineer, surface finishing methods may be varied from this procedure provided a dense, uniform surface, free of surface compaction planes, is produced. The moisture content of the surface material must be maintained within the specified range during all finishing operations. Surface compaction and finishing shall proceed in such a manner as to produce, in not more than two hours, a smooth, closely knit surface, free of cracks, ridges or loose material conforming to the crown, grade, and line shown on the plans.

After the fly ash treated course has been finished as specified herein, the surface shall be protected against rapid drying by either of the following curing methods for a period of not less than three days or until the surface or subsequent courses are placed:

- (a) Maintain in a thorough and continuously moist condition by sprinkling.
- (b) Apply a two-inch layer of earth on the completed course and maintain in a moist condition
- (c) Apply an asphalt membrane to the treated course, immediately after same is completed, the quantity and type of asphalt approved for use by the Engineer shall be sufficient to completely cover and seal the total surface of the base between crown lines and all voids. If the Contractor elects to use this method, it shall be the responsibility of the Contractor to protect the asphalt membrane from being picked up by traffic by either sanding or dusting the surface of same. The asphalt membrane may remain in place when the proposed surface or other base courses are placed. Asphaltic emulsions are not acceptable for the asphaltic membrane.

After the fly ash treated course has been finished a specified, the treated area shall remain free of all construction & vehicular traffic for a minimum of 24 hours.

## **D.2.10 Revision of Section 401 – Plant Mix Pavements**

**REVISION OF SECTION 401  
PLANT MIX PAVEMENTS – GENERAL  
(NON-VOIDS ACCEPTANCE)**

**Delete subsection 401.02(a) and replace with the following:**

Prior to beginning paving each calendar year, the contractor shall submit to the County for review and approval, a mix design for each mix type he proposes placing in Larimer County right of way. The County may also require mix designs from the Contractor during the year because of changes in the physical properties or source of the aggregates, or physical properties or source of the binder. Mix designs shall be developed using the SuperPave method of designing paving mixtures.

(a) *Mix Design.* The Contractor shall submit the following to the Engineer:

A proposed plant mix pavement mix design from an independent Laboratory prepared in accordance with Colorado Procedure 52, including a proposed job-mix gradation for each mixture required by the Contract which shall be wholly within the Master Range Table, Table 703-3A, B, and C, before the tolerances shown in Table 401-1 are applied. The weight of lime shall be included in the total weight of the material passing the No. 200 sieve. The restricted zone boundaries given in the Asphalt Institutes' SuperPave Series No. 2 (SP-2) Manual are to be used as guidelines in mix design development. However, the job-mix gradation is not required to pass above or below the restricted zone boundaries.

The job-mix formula for each mixture shall establish a single percentage of aggregate passing each required sieve size, a single percentage of bituminous material to be added to the aggregate, and a single temperature for the mixture at the discharge pint of the plant.

No hot mix asphalt (HMA) shall be placed prior to submittal of a mix design and approval of the job-mix formula.

**Subsection 401.02(b) shall include the following:**

The top layer of HBP shall not contain any reclaimed asphalt pavement. Layers below the top layer shall not contain more than 15 percent reclaimed asphalt pavement. The reclaimed asphalt pavement shall meet the requirements for subsection 703.04.

**Delete subsection 401.11 and replace with the following:**

**401.11 Tack Coat.** When ordered by the Engineer, a tack coat shall be applied between pavement courses. Tack coat shall be applied to all existing asphalt surfaces that are more than 12 hours old or have not been kept clean.

**Subsection 401.16 shall include the following:**

Thickness Tolerance. In place pavement thickness shall be determined as follows. The pavement shall be cored at 500 foot intervals, or fraction thereof, in each 12 foot lane (nominal), with a minimum of 3 cores taken for any area. The County may require additional cores to define deficient areas. Any deficiency in the total thickness of the asphaltic pavement shall not exceed ½ inch for any one sample with the average deficiency for all samples not to exceed ¼ inch. Final decision for correction of deficiencies shall be made by the Engineer.

**In Subsection 401.16 delete paragraph nine (9) and replace with the following:**

The Engineer will delineate the areas to be evaluated and inform the contractor of the location and extent of these areas.

**In Subsection 401.16 delete the last paragraph and replace with the following:**

Coring will be done at the expense of the Contractor.

## D.2.11 Revision of Section 403 – Hot Mix Asphalt

**REVISION OF SECTION 403  
HOT MIX PAVEMENT**

**Subsection 403.02 shall include the following:**

The design mix for hot mix asphalt shall conform to the following:

**TABLE 403-1**

Property	Test Method	Values For All Gradings		
		(75)	(100)	Comments
Air Voids, percent at: N (initial) [information only] N (design)	CPL 5115	>9.5 3.5 – 4.5	>11.0 3.5 – 4.5	
Lab Compaction (Gyrations): N (initial)[ information only] N (design)	CPL 5115	7 75	8 100	
Stability, minimum	CPL 5106	28	30	
Aggregate Retained on the No. 4 Sieve with at least 2 Mechanically Induced fractured faces, % minimum	CP 45	70	70	
Accelerated Moisture Susceptibility Tensile Strength Ratio (Lottman), minimum	CPL 5109 Method B	80%	80%	
Minimum Dry Split Tensile Strength, kPa (psi)	CPL 5109 Method B	205 (30)	205 (30)	
<i>Grade of Asphalt Cement, All Layers</i>				See Table 403-3 and 403-4
Voids in the Mineral Aggregate (VMA) % minimum	CP 48	See Table 403-2	See Table 403-2	
<i>Voids Filled with Asphalt (VFA), %</i>	AI MS-2	65 - 80	65 - 75	
<i>Dust to Asphalt Ratio: Fine Gradation Course Gradation</i>		0.6 – 1.2 0.8 – 1.6	0.6 – 1.2 0.8 – 1.6	

Note: AI MS-2 = Asphalt Institute Manual Series 2

Note: The current version of CPL 5115 is available from the Colorado Department of Transportation Region 4 Materials Engineer.

- Note: Mixes with gradations having less than 40% passing the No. 4 sieve shall be approached with caution because of constructability problems.
- Note: Table 1 of CPL 5115, which contains the laboratory mixing and compaction temperatures to be used for mix design development and laboratory verification of project produced mixtures, is deleted for this project and replaced with the following:

**CPL 5115 TABLE 1**

Superpave Binder Grade	Laboratory Mixing Temperature, °C(°F)	Laboratory Compaction Temperature, °C(°F)
PG 58-28	154 (310)	138 (280)
PG 58-22	154 (310)	138 (280)
PG 64-22	163 (325)	149 (300)
PG 70-28	163 (325)	149 (300)
PG 64-28	163 (325)	149 (300)
PG 58-34	154 (310)	138(280)
PG 76-28	163 (325)	149 (300)

**TABLE 403-2**

Minimum Voids in the Mineral Aggregate (VMA)			
Nominal Maximum Size*, mm (inches)	Design Air Voids **		
	3.5%	4.0%	4.5%
37.5 (1½)	11.6	11.7	11.8
25.0 (1)	12.6	12.7	12.8
19.0 (¾)	13.6	13.7	13.8
12.5 (½)	14.6	14.7	14.8
9.5 (⅜)	15.6	15.7	15.8

\* The Nominal Maximum Size is defined as one sieve larger than the first sieve to retain more than 10%.

\*\* Interpolate specified VMA values for design air voids between those listed.

In an effort to simplify the binder selection process, the following binder grades have been specified for the various types of construction and road classifications. Included in this table are the design gyration requirements.

**Table 403-3  
Binder Grade and Design Gyration Requirements**

New Construction or Reconstruction			Overlay		
Local	PG 58-28	(75)	Local / Residential	PG 58-28	(75)
Minor Collector	PG 64-28	(75)	Minor Collector	PG 64-22	(75)
Major Collector	PG 64-28	(75)	Major Collector	PG 64-22	(75)
Industrial / Commercial	PG 64-28	(100)	Industrial / Commercial	PG 64-22	(100)
Arterial	PG 64-28	(100)	Arterial	PG 64-22	(100)

Table 403-3 lists the minimums however, Larimer County may require grade bumping to account for extreme traffic flow and traffic loading conditions on Collector and Arterial roadways. This may be required on new construction, reconstruction and overlays and will be determined based on Table 403-4.

**Table 403-4  
Grade Bumping Criteria**

Condition	Binder Grade Increase
Slow Moving Traffic Loads	1 Grade Higher Than Free Flowing
Standing Traffic Loads	2 Grades Higher Than Free Flowing
Total 18k ESAL “ 10,000,000	1 Grade Higher Than Free Flowing
Total 18k ESAL “ 30,000,000	2 Grades Higher Than Free Flowing
<ol style="list-style-type: none"> <li>1. Free flowing traffic is traffic at speeds greater than 45 miles/hour</li> <li>2. Slow moving traffic is traffic moving between 12 miles/hour and 45 miles/hour</li> <li>3. Standing traffic is traffic moving less than 12 miles per hour</li> <li>4. No adjustment will be allowed for the low temperature grade because of traffic speed or volume</li> </ol>	

The Contractor shall prepare a quality control plan outlining the steps taken to minimize segregation of HBP. This plan shall be submitted to the Engineer and approved prior to beginning the paving operations. When the Engineer determines that segregation is unacceptable, the paving shall stop and the cause of segregation shall be corrected before paving operations will be allowed to resume.

The top layer of HBP shall not contain any reclaimed asphalt pavement. Layers below the top layer shall not contain more than 15 percent reclaimed asphalt pavement. The reclaimed asphalt pavement shall meet the requirements for subsection 703.04.

The contractor shall use an approved anti-stripping additive. The type and amount may be either of the following:

**Liquid Additive** – The amount of additive used shall be a minimum of 0.5 percent by weight of the asphalt cement. The additive shall be added at the refinery or at the hot plant. If the liquid anti-stripping additive is added at the plant, an approved in-line blender must be used. The blender shall be in the line from the storage tank to the drier drum or pug mill. The blender shall apply sufficient action to thoroughly mix the asphalt cement and anti-stripping additive.

**Hydrated Lime** - A minimum of 1 percent hydrated lime by mass (weight) of the combined aggregate shall be added to the aggregate for all hot mix asphalt.

**Subsection 403.03 shall include the following:**

The contractor shall construct the work such that all roadway pavement placed prior to the time paving operations end for the year, shall be completed to the full thickness required by the plans. The Contractor's Progress Schedule shall show the methods to be used to comply with this requirement.

**Subsection 403.05 shall include the following:**

The Contractor shall collect the scale ticket on each load when it is delivered to the project site, and ensure that the information required in subsection 109.01 is shown on each ticket.

The scale tickets shall be available on site for county personnel to inspect.

## **D.2.12 Revision of Section 412 – Portland Cement Concrete Pavement**

### **REVISION OF SECTION 412 PORTLAND CEMENT CONCRETE PAVEMENT**

**Subsection 412.16 shall include the following:**

The Contractor shall be responsible for taking adequate steps to protect concrete placed during precipitous, hot or cold weather. Any concrete damaged by precipitation or extreme temperatures shall be removed and replaced.

It shall be the Contractor's responsibility to protect, by the use of barricades, signs, etc., fresh concrete from damage as a result of vandalism or other causes; damaged concrete shall be repaired or removed and replaced.

**Subsection 412.21 shall be deleted and replaced with the following:**

The thickness of the pavement shall be determined by average caliper measurement of cores tested. A minimum of 2 cores per 1000 square yards will be taken at random. Should any deviation be found, additional cores may be taken to define the horizontal limits of the deviation. When measurement of the core from a unit is not deficient by more than 1/2 inch from the design thickness, the pavement thickness will be considered to be within acceptable tolerance. When such measurement is deficient more than 1/2 inch, two additional cores at intervals not less than 300 ft will be taken and used to determine the average thickness for that area. When the average thickness of pavement area is deficient by more than 1/2 inch the Engineer may require that the area be removed and replaced.



### **D.2.13 Revision of Section 601 – Structural Concrete**

#### **REVISION OF SECTION 601 STRUCTURAL CONCRETE**

**In Subsection 601.14 Delete the third paragraph and replace with the following:**

Structural Concrete Coating shall be the final finish for all exposed concrete surfaces on concrete box culverts, bridges, headwalls and similar structures unless approved otherwise by the Engineer.

### **D.2.14 Revision of Section 609 – Curb and Gutter**

#### **REVISION OF SECTION 609 CURB AND GUTTER**

**Delete Subsection 609.01 and replace with the following:**

**609.01** This work consists of the construction of curb, gutter, combination curb and gutter, or combination curb, gutter and sidewalk in accordance with these specifications and in conformity with the lines and grades shown on the plans or established.

The types of curb are as designated on the approved plans and in the M-standards.

**Subsection 609.03 (e) shall include the following:**

Expansion joint material shall be installed every 500' and between newly installed concrete and any existing structures including inlets, driveways, fire hydrants, poles, sidewalk under walk culverts, mid block ramps, at radius points at intersections, and other fixed objects. Expansion joint material shall be set vertical, and have the top edge flush with the finished surface. The joint shall be edged with a suitable edging tool.

**Subsection 609.03 shall include the following:**

All underground utilities shall be installed prior to the construction of curbs, gutters, combination curb and gutter, or combination curb, gutter and sidewalk.

The Contractor shall be responsible for taking adequate steps to protect concrete placed during precipitous hot or cold weather. Any concrete damaged by precipitation or extreme temperatures shall be removed and replaced.

It shall be the Contractor's responsibility to protect, by the use of barricades, signs, etc., fresh concrete from damage as a result of vandalism or other causes; damaged concrete shall be repaired or removed and replaced.

## D.2.15 Revision of Section 629 – Survey Monumentation

### REVISION OF SECTION 629 SURVEY MONUMENTATION

Section 629 of the Standard Specifications is hereby revised for this project as follows:

Subsection 629.02 Delete paragraph 2, sentence 1 and 2 and replace with the following:

Monuments and Monument Boxes will be furnished by the contractor. The various types of monuments shall be constructed according to the details shown on the Standard Plan M-629-1.

Subsection 629.07 shall be deleted and replaced with the following:

**629.07 Monument Box.** This work shall consist of installing new Monument Boxes at locations shown in the plans. Monument Boxes shall be placed in accordance with the drawing below.

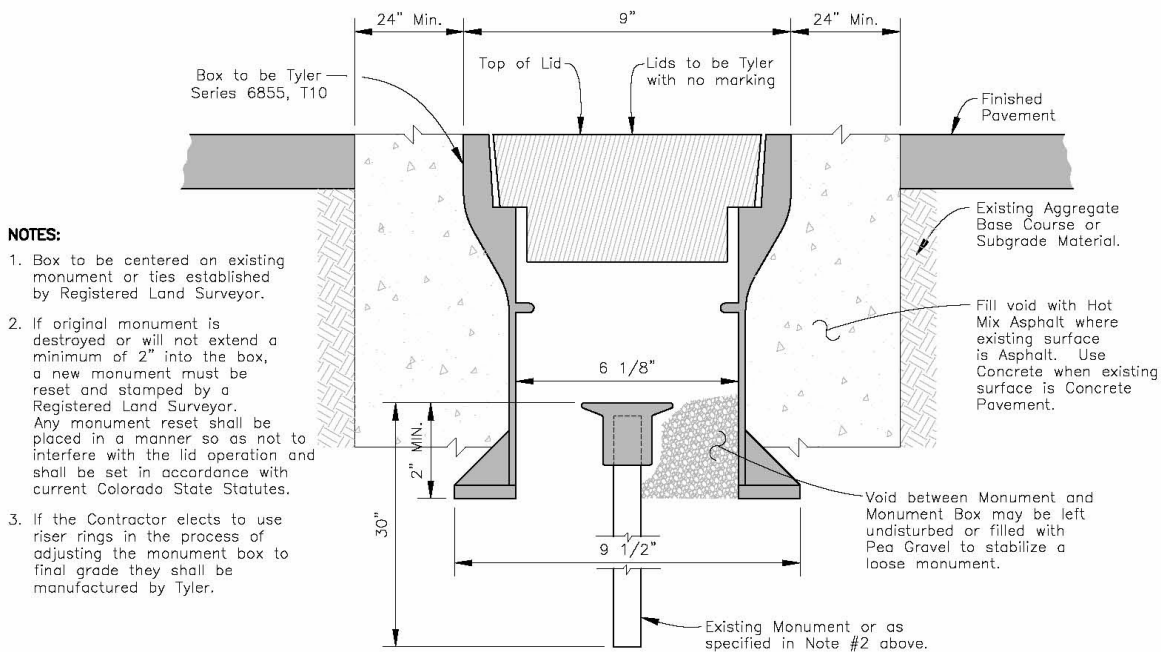

**TYPICAL SURVEY MONUMENT BOX**

## APPENDIX E – CONSTRUCTION TESTING FREQUENCIES

Soils	AASHTO	ASTM	Frequency
Sampling	T87	D420	
Soil Classification	M145	D3282 D2488/D2487	Per soil type encountered
Moisture-Density (Proctor)			Per soil type encountered
Standard	T99	D698	As specified in Geotechnical Report
Modified	T180	D1557	As specified in Geotechnical Report
Density and Moisture Content	T238 & T239	D2922 & D3017	"Right of Way"
-Grading			1/1000 cubic yards
-Embankment (Subgrade)			1/500 lf/lane (min. of 1 per street) 1' vertical
-Base Course			1/500 lf/lane (min. of 1 per street)
-Structural Backfill			1/25 lf horizontal and per 1' vertical (Min. 3 per structure)
-Utility Trench			
-Main			1/100 lf horizontal & per 1.5' vertical
-Services			2 per service (vertical)
-Manhole/Fire Hydrants			1/2' vertical within 2' alternating directions (min. of 4)
<b>Hot Mix Asphalt (HMA)</b>			
Sampling	T168	D979	
Density			
-Nuclear	----	D2950	1/500 lane feet (min. of 3 per street) per lift per area paved
-Coring	T166	D2726	As required or directed. Establish correction for Nuclear gauge.
-Max. Theoretical (Rice)	T209	D2041	As required or directed. Min. 1/2000 ton
Asphalt Content			1/500 tons
Solvent	T164	D2172	
Ignition Oven	T308	D6307	
Nuclear	T287	D4125	
Thickness		D3549	Core for thickness - 1/1000 lf/lane (min 1 per street)(4" diameter)
Aggregate Gradation	T27	D5444 or C136	1/1000 ton
Fractured Faces		D5821	Within first 1000 ton then 1/10,000 ton
Lottman	(CP-L 5109)(Method B)		Within first 1000 ton then 1/10,000 ton
Fine Aggregate Angularity	T 304	C 1252	Within first 1000 ton then 1/10,000 ton
Mix Verification Test – (to verify that field produced HMA conforms to approved JMF) Includes – Air Voids, VMA, VFA, AC Content, Rice, Gradation, Stability (HVEEM)			Within first 1000 ton then 1/10,000 ton
<b>Concrete</b>			
Sampling	T141	C172	
Mold and Cure	T23	C31	
Transportation of Cylinders	T23	C31	
Physical Properties			1/100 cubic yards/One per day Min.
Slump	T119	C143	
Air Content	T152	C231	
Compressive Strength	T22	C39	
Obtaining Cores	T24	C42	As required or directed
Compressive Strength of Cores	T24	C42	As required or directed
<b>Aggregate Base Course</b>			
Gradation	T27	C136	Per source or as required or directed
Moisture-Density (Proctor)			Per source or as required or directed
Modified	T180	D1557	As specified in Geotechnical Report or Specifications
Standard	T99	D698	As specified in As specified in Geotechnical Report or Specifications Geotechnical Report
Density/ Moisture Content			1/1000 lf/Lane--Min. 3 per street

# APPENDIX F – GUIDELINES FOR TRAFFIC IMPACT STUDIES

## F.1 PURPOSE AND OVERVIEW

A Traffic Impact Study is required to analyze the effects of a proposed development or other land use action on the transportation system in order to determine if adequate public facilities exist to serve the proposed development, and to clearly identify any improvements required to mitigate the impacts on the transportation system. The applicant for a development proposal or other land use action must submit a Traffic Impact Study as described herein.

### F.1.1 Types of Traffic Impact Studies

Larimer County may require Traffic Impact Studies as follows:

1. Paving Threshold Study. The County requires a Paving Threshold Study for any proposed development or land use action that will impact unpaved or gravel roads as described in Section F.4 below.
2. Intermediate Traffic Impact Study. The County requires an Intermediate Traffic Impact Study for any proposed development or land use action that will impact paved roads as described in Section F.5.
3. Full Traffic Impact Study. The County requires a Full Traffic Impact Study for a proposed development or land use action that will have a major effect upon traffic, as described in Section F.6.
4. Any proposed development or land use action which creates less than three new dwelling units or generates less than twenty-one new daily trips will not be required to submit a traffic impact study. Such development would, however, be required to pay transportation capital expansion fees in effect at the time.

### F.1.2 Responsibility and Qualifications

The responsibility for assessing the traffic impacts associated with a proposed development or other land use action rests with the Applicant. Paving Threshold and Traffic Impact Studies shall be prepared under the supervision of a professional engineer registered in the State of Colorado with appropriate experience in transportation and traffic engineering.

### F.1.3 Scoping

The applicant is required to contact the Engineer to arrange for scoping of the TIS. The purpose of the scoping is to determine and document the parameters for the study of traffic impacts for a specific development project. The parameters determined in the scoping represent general agreement between the County and the consulting engineer, but they may not be all inclusive. The Engineer retains the right to require any additional information and / or analysis to complete an evaluation of the proposed development project.

It is incumbent upon the Applicant to supply a completed Transportation Impact Study Base Assumptions Form and be prepared during scoping to discuss:

1. Previous TIS prepared for the site, if any
2. Location of the site

3. Proposed access(es) and their relationship to adjacent properties and their accesses
4. Preliminary estimates of the site's trip generation, trip adjustment factors, if any, and trip distribution at build-out
5. Proposed phasing plan and anticipated year of build-out
6. Anticipated roadway improvements
7. Special analysis needs

Completion of the TIS scoping will result in mutual agreement between the County and the Applicant regarding the level of detail and extent to which the TIS will need to address each of the following:

1. Study area for the impact analysis
2. Other development to include
3. Existing intersection counts
4. Intersections to be studied
5. Background traffic volume forecasts
6. Special Analysis needs (This may include consideration and/or comparative analysis of modern roundabouts as intersection control type)

The completed and signed base assumptions form and any attachments shall be inserted in the TIS.

#### **F.1.4 Review by County**

The Engineering Department will review all traffic impact studies, with input from other county departments as needed. All studies must be approved by the Engineer.

## **F.2 DEFINING A TRAFFIC IMPACT AREA**

Traffic impacts must be analyzed within a traffic impact area. The limits of this impact area shall be based on the size and extent of the application for development approval, the existing and future land uses, and traffic conditions on and near the site. Determination of the boundaries of the traffic impact area is at the discretion of the Engineer, but is typically done in consultation with the Applicant during the scoping meeting.

Because concerns related to traffic impacts due to specific land use actions can vary greatly, the determination of a traffic impact area is done on a case-by-case basis; however, at a minimum the limits of the study area should include:

- A. Internal roads
- B. Adjacent roads
- C. Access locations and/or new intersections
- D. Off-site roads to the nearest paved County collector or arterial road or state highway

- E. Off-site roads where traffic from the proposed development or land use action will account for at least 20% of the average daily traffic upon build-out.
- F. Off-site intersections where traffic from the proposed development or land use action:
  - 1. Contributes a 10% impact of the peak hour traffic on any approach leg of an intersection where the intersection is operating at a level of service C or better upon build-out.
  - 2. Contributes a 5% impact of the peak hour traffic on any approach leg of an intersection where the intersection is operating at a level of service D or worse upon build-out.
  - 3. Impacts a specific turning movement that currently does not have an auxiliary turn lane by at least 50% of the peak hour volume warrant for an auxiliary turn.

### **F.3 LEVEL OF SERVICE, ACCESS, AUXILIARY LANE REQUIREMENTS AND PASSENGER CAR EQUIVALENTS**

- A. The acceptable level of service (LOS) (per the Highway Capacity Manual) for rural roadways in unincorporated Larimer County (outside Larimer County adopted growth management areas) is detailed in the Larimer County Land Use Code and is a LOS C.
- B. Access spacing is detailed in Chapter 10 of this document.
- C. Auxiliary lane warrants are included in Chapter 4 of this document.
- D. Unless specifically noted, all criteria in these standards are based on automobile operations and performance. To allow for the impact of larger trucks, buses, and recreational vehicles, “passenger car equivalents” shall be determined. A passenger car equivalent of 3 for each bus and all trucks and combinations of 40 feet in length or longer, or a passenger car equivalent of 2 for each vehicle or combination at or over 20 feet in length but less than 40 feet shall be used for these purposes.

### **F.4 PAVING THRESHOLD STUDY**

#### **F.4.1 When a Paving Threshold Study is Required**

The County requires a Paving Threshold Study for any development proposal that will create more than two (2) new dwelling units or that is expected to generate more than twenty (20) new daily vehicle trips on an unpaved or gravel road in the traffic impact area.

#### **F.4.2 Paving Threshold Study Requirements**

The Paving Threshold Study must include at least the following information:

- 1. A location map showing the development site, the boundaries of the traffic impact area, and all roads, intersections, bridges or other roadway structures in the traffic impact area.
- 2. Identification of all unpaved or gravel roads in the traffic impact area and a determination as to whether the gravel has been treated with chemicals for dust suppression.

3. Identification of all bridges or other roadway structures in the traffic impact area that have been determined to be structurally deficient or functionally obsolete by the Engineer.
4. Current and projected average daily traffic volumes on all unpaved or gravel roads in the traffic impact area. Projected daily traffic volumes shall be based on full buildout of the proposed development or land use action and on any committed (approved) development that would contribute to the traffic volumes on roads in the traffic impact area.
5. A brief summary of whether or not the capacity and level of service requirements for the unpaved or gravel roads will be satisfied if the proposed development or land use action is approved and constructed. If the capacity and level of service requirements will not be satisfied, describe the improvements that must be constructed to satisfy the requirements. In addition, provide a brief analysis of the adequacy of road pavements and/or bridges and roadway structures in the traffic impact area (See Section F.7, below).

## **F.5 INTERMEDIATE TRAFFIC IMPACT STUDY**

### **F.5.1 When an Intermediate Traffic Impact Study is Required**

The County requires at least an Intermediate Traffic Impact Study for any proposed development or land use action that will generate traffic volumes that will impact the capacity, safety, or structural integrity of the roadway system. The following are examples of proposed developments or land use actions that will require an Intermediate Traffic Impact Study:

1. Rezoning. A rezoning application increasing the intensity of land use where a traffic impact study has previously been approved.
2. Plats. Any general development plan or preliminary plat meeting the following criteria, or a final plan meeting the criteria when a traffic impact study was not approved for the preliminary plat.
  - a. Residential Plats: Residential plats with more than 2 but no more than 20 new dwelling units.
  - b. All Other Plats: All other plats where the volume of new traffic generated will be more than 20 but no more than 200 vehicle trips per day. Plats with access to collector or arterial roads may require an analysis of access design and location.
3. Site Plans or Special Reviews. Any site plan or special review where the volume of new traffic generated will be more than 20 but no more than 200 vehicle trips per day.

### **F.5.2 Intermediate Traffic Impact Study Requirements**

The Intermediate Traffic Impact Study must include at least the following information:

1. A location map showing the development site, the boundaries of the traffic impact area, and all roads, intersections, bridges or other roadway structures in the traffic impact area.
2. Identification of all paved roads in the traffic impact area, a description of the type of pavement, and a description of the condition of the pavement.

3. Identification of all existing and proposed traffic signals in the traffic impact area.
4. Identification of all bridges or other roadway structures in the traffic impact area that have been determined to be structurally deficient or functionally obsolete by the Engineer.
5. A summary table listing each type of land use in the proposed development or land use action, the size or amount involved, the trip generation rates used, and the resultant average daily trips generated. Trip generation must be calculated using the latest data contained in the Institute of Transportation Engineers (ITE) Trip Generation manual. If several trip generation rates are listed in the ITE manual, use the highest rate or provide sufficient justification for a lower rate. Trip generation rates for any land use not easily defined using the ITE manual or from any other trip generation data source must be clearly noted.
6. The percentage distribution of trips from the proposed development or land use action to other roads in the traffic impact area.
7. Current and projected average daily traffic volumes on all roads in the traffic impact area. Projected daily traffic volumes shall be based on full buildout of the proposed development or land use action and on any committed (approved) development that would contribute to the traffic volumes on roads in the traffic impact area as well as growth in background traffic.
8. A description of capital improvements to roads in the traffic impact area that are under construction or planned by any public agency or private entity and the schedule for completing such improvements.
9. A summary of whether or not the requirements for capacity, level of service, and adequacy of pavements and structures (See Section F.7, below) for all roads in the traffic impact area will be satisfied if the proposed development or land use action is approved and constructed. If the capacity, level of service, and adequacy of pavement and structure requirements will not be satisfied, describe the improvements that must be constructed to satisfy the requirements.

## **F.6 WHEN A FULL TRAFFIC IMPACT STUDY IS REQUIRED**

### **F.6.1 When a Full Traffic Impact Study is Required**

A Full Traffic Impact Study will be required for any proposed development or land use action that will create more than 20 new dwelling units or generate more than 200 new vehicle trips per day, or when determined to be necessary by the Engineer.

### **F.6.2 Full Traffic Impact Study Requirements**

The Full Traffic Impact Study must include at least the following information:

1. Describe the traffic impact area, including at a minimum those elements described in Section F.2. The traffic impact area must be expanded to include the following:
  - a. All pedestrian or bicycle routes within 1 ½ mile of a school
  - b. All routes to any public or commercial attraction within a ten minute walk or bicycle ride from the site.
  - c. All routes to transit facilities within a ten minute walk of the site.



2. Define the following study horizons for the Full Traffic Impact Study: the existing (current), short range, and long range horizons.
  - a. Existing Horizon: The intent of the existing or current horizon is to establish a baseline traffic condition.
  - b. Short Range Horizon: The intent of the short term horizon is to evaluate the immediate impacts of the project on the transportation system. The short term horizon year is defined as the point of full buildout of the proposed development or land use action. If the project is proposed to occur over multiple phases, the impacts shall be analyzed at the point of full buildout of each phase. In no case shall the short range horizon exceed five (5) years.
  - c. Long Range Horizon: The intent of the long range planning horizon is to evaluate the impacts of the fully developed project in the context of regional transportation planning efforts. The long range impacts are analyzed as of the end of the current Regional Transportation Plan 20-year planning horizon. If no long range analysis year is established, the long range horizon should be twenty years after the existing horizon.
3. Identify the existing, committed (approved), and proposed land uses in the traffic impact area.
4. Prepare a map of transportation facilities within the traffic impact area for both the short range and long range planning horizons including, but not limited to, all existing and proposed roads, access points, and intersections. Include committed (funded) improvements by the County or by previously approved developments or land use actions. This map should be used to graphically display average daily and peak hour traffic volumes for the existing, short range, and long range planning horizons.
5. Describe existing traffic conditions within the traffic impact area, including average daily traffic volumes for roadways and a.m. and p.m. peak hour volumes at intersections. These volumes must be based on traffic counts no more than two years old. Determine a.m. and p.m. peak hour levels of service for intersections.
6. For short range traffic projections, provide references, calculations and data sources for all trip generation estimates, as follows. Use and document the following procedures for all trip generation estimates:
  - a. Obtain trip generation estimates or equations from the Institute of Transportation Engineers (ITE), Trip Generation Manual. Where several trip generation rates are listed in ITE Trip Generation Manual, use the highest trip generation rate or provide sufficient justification for a lower rate.
  - b. Where no published trip generation rates are available, the Engineer will consider fully documented traffic volume counts for similar existing uses.
  - c. Trip reduction factors may be applied under the following conditions:
    - 1) Basic requirements. Trip reduction factors may be applied to the full trip generation estimates derived from ITE rates or equations, only after underlying assumptions of the full ITE rates have been examined. All trip reduction factors must be fully quantified and justified in the Full Traffic Impact Study or its appendix.
    - 2) Reassigning generated trips to passby factor. Passby factor denotes trips to the proposed development that currently exist as background mainline

traffic. Passby traffic must still be counted at site driveways and access points, but can be taken out of the background mainline traffic. Passby rates can be used from ITE Trip Generation Manual or other transportation publications. The Full Traffic Study must clearly illustrate re-diversion of the passby trips.

- 3) Other adjustments to trip generation estimates. Adjustments may also be taken for internal site trips, transit use, and transportation demand management strategies (TDM). Implementation proposals must be given for optimistic adjustments from transit use and TDM strategies. Such proposals will become conditions of approval, and must be reasonably expected to occur within five years after site build-out.
- d. Show the results of the trip generation calculations in a matrix table with the following information:
  - 1) Land use
  - 2) Unit of measurement (for example, per dwelling unit, per 1000 s.f., etc.)
  - 3) Total number of units
  - 4) Trip generation rates per unit for average daily traffic and peak hour volumes
  - 5) Total number of trips generated for average daily traffic and a.m. and p.m. peak hours
7. Short range and long range traffic projections must also include forecasts for the growth in background traffic. Growth rates must be approved during the scoping and may be based on one of the following (and clearly documented):
  - a. Proportion between existing traffic volumes and projected volumes from the regional model
  - b. Extrapolation from historical counts
  - c. Planning analysis which considers trends in the vicinity of the traffic impact area either through a proportion or extrapolation estimate
8. Provide trip distribution estimates for the roads and intersections in the traffic impact area, and document the basis for these estimates. Assign the traffic based on these trip distribution estimates for both short range and long range planning horizons, graphically presented on the map described in Section D, above.
9. Present the volumes for short range and long range traffic including the projected traffic for the proposed development or land use action for the a.m. and p.m. peak hour and average daily conditions. These volumes must include turn movements at intersections as well as volumes for roads in the traffic impact area.
10. Analyze the adequacy of the transportation system to handle the projected traffic for short range and long range planning years. Key elements in this analysis should include:
  - a. Generalized daily traffic volume level of service for roadways
  - b. Intersection levels of service for a.m. and p.m. peak hours

- c. The appropriateness of access locations and the need for future traffic signals
  - d. The need for auxiliary lanes (turn lanes, deceleration and acceleration lanes), including explanations of how acceleration/deceleration lengths, storage lengths, and taper lengths were determined
  - e. Sight distances
11. If the County has determined that the proposed development includes or affects high hazard locations, provide traffic accident data for all roadways in the study area. The accident data shall cover a minimum period of two years prior to the proposed study time. Accident data summaries for county roads may be obtained from the County Engineering Department.
12. Provide a summary of conclusions and recommendations from the Full Traffic Impact Study, including at least the following items:
- a. A summary listing of traffic impacts from the proposed development on existing and proposed roads, intersections, and traffic signals in the traffic impact area.
  - b. A summary listing of improvements needed to assure adequate service and safety levels on the roadway system affected by the proposed development. Identify and describe each proposed improvement, how and when it will be funded, and expected completion dates.

## **F.7 ADDITIONAL REQUIREMENTS**

In addition to the above requirements, the following shall be provided upon the request of the Engineer:

- A. **Roadway Surface and Structural Integrity Analysis.** Provide the following:
  - 1. Analyze the existing structural integrity of all roads in the traffic impact area significantly impacted by the proposed development. The Engineer may require analysis of affected roadways outside the traffic impact area.
  - 2. Identify impacts from additional site generated traffic on the existing surface. Identify improvements needed to maintain surface and structural integrity at acceptable County standards.
  - 3. The Engineer may require pavement cores if historic composite thicknesses are not available.
  
- B. **Structural Analysis of Bridges.** Provide the following analysis for structurally deficient or functionally obsolete bridges impacted by the proposed development.
  - 1. Analyze current conditions of any structurally deficient or functionally obsolete bridges.
  - 2. Evaluate impacts of added site generated traffic upon such bridges.
  - 3. Identify structural or operational improvements needed to maintain the safe operation of such bridges satisfactory to the Engineer.

**Attachment A  
 Transportation Impact Study  
 Base Assumptions**

<b>Project Information</b>			
Project Name			
Project Location			
<b>TIS Assumptions</b>			
Type of Study	Full:		Intermediate:
Study Area Boundaries	North:		South:
	East:		West:
Study Years	Short Range:		Long Range:
Future Traffic Growth Rate			
Study Intersections	1. All access drives		5.
	2.		6.
	3.		7.
	4.		8.
Time Period for Study	AM: 7:00-9:00	PM: 4:00-6:00	Sat Noon:
Trip Generation Rates			
Trip Adjustment Factors	Passby:		Captive Market:
Overall Trip Distribution	SEE ATTACHED SKETCH		
Mode Split Assumptions			
Committed Roadway Improvements			
Other Traffic Studies			
Areas Requiring Special Study			

Date: \_\_\_\_\_

Traffic Engineer: \_\_\_\_\_

Larimer County Engineer: \_\_\_\_\_

# APPENDIX G – DESIGN AND CONSTRUCTION STANDARDS FOR PRIVATE LOCAL ACCESS ROADS

## G.1 GENERAL

### G.1.1 Purpose

The purpose of the following design standards is to safeguard life, limb, property and the public welfare by regulating construction of private local access roads serving either multiple residences or businesses that serve the general public. They also provide design recommendations for private roads accessing single residences. The regulations are intended to:

- Establish reasonable minimum standards for emergency access and roadway safety
- Encourage that private local access roads and driveways meet these standards while minimizing the amount of site disruption caused by such construction.

These minimum design standards for safe, maintainable roadways should balance the desire to preserve the natural terrain and landscapes of rural areas in the County while maintaining fairness and respect for individual rights. These standards are not intended to inhibit creative design, provided that safety is maintained and site disturbance is minimized, nor are they intended to prevent development of private property in Larimer County. The intent is to encourage roadways which “fit” with the natural terrain while providing safe, functional roads. Maximum creativity in design is encouraged when designing rural access roads.

### G.1.2 Administration

1. **General.** Permitting for, and enforcement of, this regulation shall be administered through the Larimer County Engineering Department by the County Engineer or his designated representative. The final design of the road is intended to be a cooperative effort between the landowner, the Engineer and other consulting parties as needed. Administration of this regulation shall be driven by the objective of attaining site-specific road design and construction that will meet the minimum requirements for reasonable emergency access, roadway safety, protection of soil and water natural resources and that respects the landowner’s individual rights.
2. **Administrative Appeal.** In order to assure a flexible, site specific design process, deviations from the standards may be granted for some requirements at the discretion of the Engineer. Deviations from the design standards must be considered on a site by site basis and must assure that the final design of the road will not unduly compromise the minimum requirements for emergency access and roadway safety. Such deviations must be granted in writing by the Engineer.
3. **Enforcement.** After August 23, 1999, construction of a private local access road which accesses more than one residential property (Multiple Access Road), without proper permitting and certification is a violation of this regulation. If the road is not in compliance, proper permitting and reconstruction of the road to

meet the standards as described in this regulation must be completed before its use as a Multiple Access Road. The County may enforce this regulation by any legal or equitable means recognized by the Colorado Revised Statutes, Colorado Court Rules, and/or common law. Remedies may include, but are not limited to, denial, withholding or revocation of permits, certificates or other forms of authorization to use or develop any land, structure or improvements; and initiation of court actions for injunctions, abatement, mandamus, or damages. No Larimer County Access Permit, to access a public County road, shall be granted for a private multiple access road unless it is shown to be constructed to meet the minimum requirements of this regulation.

## **G.2 PRIVATE ROAD CONSTRUCTION PERMIT REQUIREMENTS**

### **G.2.1 Multiple Access Roads**

A Private Road Construction Permit is required prior to new construction of private local access roads that are:

- intended to access multiple residences or
- private roads accessing businesses that are used by the general public in Larimer County.

Private Road Construction Permit applications will be reviewed by the Engineer or designated representative of the Larimer County Engineering Department. A site inspection may be required if sufficient information is not included with the application. In such cases a Pre-Application Inspection Report will be generated by the County Engineer. Issuance of permits requires satisfactory compliance with the Larimer County Design Standards for Private Local Access Roads.

### **G.2.2 Exception for Roads Built Before August 23, 1999**

Multiple access roads built before August 23, 1999 are exempt from these standards. The road must have been used as multiple access historically prior to this date for the exemption to apply. Otherwise it is considered a change of use and must meet these minimum standards. The Engineer will, at the owner's request, certify reconstruction of the road to conform to these County standards. In such cases the requirements of this document will apply, including associated fees.

### **G.2.3 Certification of Single Access Roads**

A permit is not required to construct the road to a single residence. The Engineer will, however, at the owner's request, certify the new construction, or reconstruction, of these roads as being built to Larimer County recommended standards. This may be done by applying for a Private Road Construction Permit and following the procedures set forth in this document for local access road construction. Any applicable inspection fees will apply.

### **G.2.4 Requirements for Application**

Application for a private road construction permit must be accompanied by a plan of sufficient clarity to indicate the nature and extent of the work. The plan must show sufficient topography to estimate the general longitudinal profile of the proposed road, extent of cuts and fills, and location of drainages, wetlands, and water features. The

plan must give the location of the work, the name of the owner, the name of the person who prepared the plan, and the contractor proposed to accomplish the work, if applicable. The plan must include the following specific information:

1. A copy of the Pre-application Inspection Report from the Larimer County Engineering Department, if applicable.
2. Horizontal alignment of the proposed road shown on a topographic map of sufficient scale to allow cut and fill volumes and longitudinal profile to be estimated.
3. Locations, dimensions, and designed flow capacity of proposed drainage structures such as culverts.
4. Typical cross-sections of the road design showing width, drainage feature dimensions, depth of road surfacing materials, and proposed sub-grade treatment. A cross section must be shown for each major change in design parameters.
5. Location of any buildings, structures, natural drainages, wetlands, and water features within 100 feet of the grading work or that may be affected by the proposed grading work.
6. An erosion control plan specific to the site conditions delineating temporary and permanent mitigation measures to minimize erosion and sediment transport. See Larimer County Stormwater Design Standards, June 20, 2005, Addendum to Volume 3 of the USDCM, for examples of accepted Best Management Practices for such mitigation measures.

### **G.3 ENGINEERED DESIGN**

In some cases, where the safety or functionality of the road is compromised by complicated or unstable geology, large stream crossings, or other complicated drainage issues, an engineered design may be required by the Engineer. In these cases the application must be accompanied by appropriate drainage reports, soils engineering reports and/or engineering geology reports as required by the Engineer. The plans and specifications must be prepared and signed by an individual licensed by the State of Colorado to prepare such plans or specifications. The engineer preparing the plans must inspect as necessary and certify that the grading was done in accordance with the final approved plan.

### **G.4 RESOLUTION OF CONFLICTS**

In cases where irreconcilable differences arise between the Engineer and the applicant, the applicant may request a variance as described in Chapter 1 of the Larimer County Rural Area Road Standards.

### **G.5 NOTICE OF COMPLETION**

The applicant must notify the Engineer or the designated official when the road is ready for final inspection. Final approval will not be given until all work, including installation of all drainage facilities and their protective devices, and all erosion control measures, has been completed in accordance with the final approved plan, and any required certifications are submitted.

## **G.6 FEES**

Application fees for plan review and field inspection(s) must be paid before the Road Construction Permit is granted. Payment of final inspection fees shall be paid before final acceptance/certification is granted.

## **G.7 ROAD DESIGN STANDARDS**

Private local roads accessing multiple residential parcels (multiple access roads) or serving businesses that will involve travel by the general public must be constructed to the following standards. Although the standards are considered to be minimums to provide a safe, functional road, they represent the idealized situation where few physical constraints exist. A typical cross section is represented in Figure 1. Many areas in rural Larimer County possess unique physical attributes which make it necessary to construct the road to fit the individual site circumstances. Deviations from the minimum standards herein, to address such problems, must be shown on the construction plans at time of permit application. Field changes must be approved in writing by the Engineer or his designated representative. They must also be shown on as-built drawings at the time of final inspection.

For roads accessing single family residences, the standards herein can be used as design guidelines. While construction of such roads to the Larimer County standards is optional, it is highly recommended and will benefit the landowner. Individuals wishing to certify construction of these roads to County standards may apply for a Private Road Construction Permit and comply with the following road design standards. All fees will apply. Reconstruction of pre-existing roads to comply with the standards may be certified in the same manner.

### **G.7.1 Road Width**

#### ***G.7.1.1 Roads accessing multiple lots (Multiple access roads)***

A driveable all-weather road surface width of 20 feet is required for an adequate two-way roadway to assure safe ingress and egress of emergency response vehicles. A narrower width for short distances, to minimize cut volumes or address other environmental concerns, may be acceptable if adequate turnouts are incorporated into the design and the road design is demonstrated to be otherwise safe and maintainable. The minimum acceptable width in these cases is 12 feet and must incorporate appropriate turnouts as described in Section G.7.6.

#### ***G.7.1.2 Roads accessing single lots***

A driveable all weather road surface width of 12 feet is recommended to assure safe ingress and egress of emergency response vehicles. To minimize cut volumes, or if topography makes this width impractical, a narrower width, for short distances, may be acceptable if the road design is demonstrated to be otherwise safe and maintainable. The minimum acceptable width in these cases is 10 feet.

#### ***G.7.1.3 Clearance height***

Access roads through forested areas must maintain proper clearance heights above the traveled way sufficient to allow passage of emergency vehicles. Tree branches must be trimmed to obtain a minimum overhead clearance of 13 feet 6 inches.



### **G.7.2 Road Grade**

Road design must incorporate a maximum longitudinal slope of 8% (10% in mountainous terrain). Road designs exceeding these longitudinal slopes must ensure that other safety and site disturbance guidelines are not compromised. Where topography requires, steeper grades may be necessary. The Engineer may grant deviations in writing for unusual cases in mountainous or hilly terrain. However, the average grade for 200 feet should not exceed 12%.

### **G.7.3 Horizontal Road Curve**

Radii of curvature on centerlines may be a minimum of 100 feet (60 feet in steep terrain), so long as adequate sight distance exists to allow a safe stopping distance. Mountainous terrain may require a deviation from this standard if topography is steep. The Engineer must approve such variance.

### **G.7.4 Vertical Road Curve**

For safety reasons, design of crest vertical curves (top of hill crests) must be based on the design speed of the road. The design speed must take into account sight distance limitations which result from extreme crest vertical curves. Correspondingly, sag vertical curves (bottom of hill) must also be designed based on the design speed, such that headlight visibility will not be compromised in nighttime or dim light conditions. Recommended design speed for most local access roads is 15 mph in steep, mountainous areas and 25 mph in rolling to flat areas.

### **G.7.5 Road Intersections**

Intersections should be within ten degrees of perpendicular for at least 50 feet from intersection centerlines with adequate sight distance both directions. If topography allows, grades should flatten to 3% or less for at least 50 feet approaching intersections.

### **G.7.6 Dead End Roads**

Dead end multiple access roads must be constructed with a vehicular turnaround area at the end or within the last 600 feet of roadway. Single access roads exceeding 600 feet in length should incorporate this standard as well. Turnarounds may take a number of forms (Figure 2), including a traditional cul-de-sac bubble, a hammerhead or “T” shape, or a turning loop. Cul-de-sac bubbles and turning loops must have a minimum radius of 40 feet. T’s must have a minimum length of 35 feet on both sides. For roads narrower than 20 feet, turnouts must be provided at approximately every 600 feet of road. Greater distances may be allowable if good sight distance is maintained between adjacent turnouts. The turnouts must be constructed to allow turning movements to be made by emergency vehicles (Figure 2). Turnouts must be an all weather road surface at least 8 feet wide and 30 feet long.

*Note: Though not a requirement in the design for 20 ft wide roads, turnouts should be considered if the road is the single access and egress point to the parcels served.*

### **G.7.7 Cuts and Fills**

Roadways should follow existing contours to the extent possible. Roadway cuts and embankments should be considered only to the extent they are necessary to maintain

safe geometric conditions for the design speed. Construction of cuts and fills in these cases must be constructed to the following requirements to maximize the safety and integrity of such work.

#### **G.7.7.1 Cuts**

- a. **General.** Unless otherwise recommended in an approved soils engineering or engineering geology report, cuts must conform to the provisions of this section.
- b. **Slope.** The slope of cut surfaces must be no steeper than is safe for the intended use and must be no steeper than 1 unit vertical in 1.5 units horizontal (66.7% slope) in common soil. Cut slopes in competent rock may be vertical when less than 3 feet high. Cut slopes in competent rock greater than 3 feet high and less than 8 feet high must be no greater than 1 unit vertical to 3 unit horizontal. Cut slopes greater than 8 feet high, or where unstable or compromising geology occurs, may require a soils engineering or an engineering geology report, or both, stating that the site has been investigated. Such reports must provide a recommended slope configuration to stabilize the constructed cut. When required by the Engineer, the report must be prepared and signed by an individual licensed by the state to prepare such plans and specifications. Construction of such cut slopes must conform to the recommendations of the report.

Cut slopes must be seeded to reestablish appropriate vegetative cover to maximize slope stability and minimize erosion. Existing topsoil on the site must be saved and stockpiled for dressing the slope prior to seeding. Mulching of the soil surface after seeding is required to minimize erosion and protect seeds while germination and plant establishment take place. These requirements may be subject to appeal when slope material not conducive to plant growth and establishment make it inappropriate. In these cases it may be necessary to use other physical or mechanical means to stabilize the slope material. Best Management Practices (BMP) and information about seeding and revegetation are available in the Larimer County Storm Water Design Standards. Copies are available at the Larimer County Engineering Department.

#### **G.7.7.2 Fills**

- a. **General.** Unless otherwise recommended in an approved soils engineering report, fills must conform to the provisions of this section.
- b. **Preparation of Ground.** Fill slopes must not be constructed on natural slopes steeper than 1 unit vertical in 2 units horizontal (50% slope). The ground surface must be prepared to receive fill by removing woody vegetation such as shrubs, topsoil and other unsuitable materials and scarifying to provide a bond with the new fill. Where slopes are steeper than 1 unit vertical in 5 units horizontal (20% slope) and the height is greater than 5 feet, stability must be achieved by benching at the toe into sound bedrock or other competent material.
- c. **Fill Material.** Composition of fill material must follow these requirements:
  - i. Detrimental amounts of organic material will not be permitted in fills.

- ii. Rock sizes greater than 12 inches in maximum dimension
  - iii. must be placed 2 feet or more below grade, measured vertically.
  - iv. Rocks must be placed so as to assure filling of all voids with well-graded soil.
  - v. The upper 2 feet of fill must be compacted for stability in preparation for placement of surfacing material.
- d. **Slope.** Fill slopes must be no steeper than 1 unit vertical in 2 units horizontal (50% slope) unless the fill is engineered and constructed in such a way as to establish stability at a steeper slope. Design of such fills must be done by an individual licensed by the state to do such work. Fill slopes must be seeded to reestablish appropriate vegetative cover to maximize slope stability and minimize erosion. Whenever possible, existing topsoil on the site must be saved and stockpiled for dressing the slope prior to seeding.

### **G.7.7.3 Slope Setbacks**

These setback recommendations are included for general consideration to avoid conflicts and potential problems with other landowners. They should be followed when planning a road or other excavations.

- a. **General.** Cut and fill slopes should be set back from site boundaries in accordance with this section. Setback dimensions are horizontal distances measured perpendicular to the site boundary. Setback dimensions should be as shown in Figure 3.
- b. **Top of Cut Slope.** The top of cut slopes should not be made nearer to a site boundary line than one fifth of the vertical height of cut with a minimum of 2 feet and a maximum of 10 feet.
- c. **Toe of Fill Slope.** The toe of fill slope should be made not nearer to the site boundary line than one half the height of the slope with a minimum of 2 feet and a maximum of 20 feet. Where a fill slope is to be located near the site boundary and the adjacent off-site property is developed, special precautions should be incorporated in the work, as necessary, to protect the adjoining property from damage as a result of such grading. These precautions may include but are not limited to:
  - 1) Additional setbacks.
  - 2) Provision for retaining or slough walls.
  - 3) Mechanical or chemical treatment of the fill slope surface to minimize erosion.
  - 4) Provisions for the control of surface waters.

### **G.7.8 Drainage**

Plans for adequate site and roadway drainage are required for all road construction. Road design must contain provisions for stormwater drainage sufficient to achieve a standard of no ponding at all locations. Adequate design must insure the natural drainage system will be maintained and erosion is minimized.

1. **Single Access Roads.** Single-residence driveways should provide cross culverts or structures crossing natural drainages as needed to maintain natural drainage patterns and conduct stormwater away from the roadway. These culverts should, at a minimum, be sized to pass the flow generated by a 10-year storm. They should be at least 12 inches in diameter and have a minimum cross-sectional area of at least 0.78 square feet. When voluntary certification is desired, all such structures must appear on the road grading plan and be accepted by the Engineer before a permit can be issued.
2. **Multiple Access Roads.** Road systems accessing multiple residences (e.g. rural subdivisions) must provide cross culverts, as needed, to maintain natural drainage patterns and distribute stormwater away from the roadway. Such structures must be sized to pass at least the flow generated by a 10-year storm. Culverts may not be smaller than 18 inches in diameter nor have cross-sectional area of less than 1.77 square feet. The Engineer may require more stringent design criteria as necessary for safety and protection of property and natural drainage patterns. Adequate sizing of such structures will be determined at the planning and design stage for such road systems and must be accepted by the Engineer before a road construction grading permit is issued.
3. **Culvert Specification.** Culverts must be either double-wall corrugated plastic or single wall corrugated metal pipe. Single-wall pipe may be acceptable if it can be demonstrated that it meets the minimum requirements of this section. A minimum of 12 inches of cover of material compacted to manufacturer's specifications is recommended unless manufacturers specifications indicate a lesser amount is sufficient to achieve the required bearing capacity. The culvert must be of sufficient strength and proper installation to assure a minimum of 10 tons bearing capacity.
4. **Bridge Specification.** Bridges must be constructed to comply with the general specifications of Chapter 7 of the Larimer County Rural Area Road Standards.

### **G.7.9 Erosion Control and Site Reclamation**

Erosion control and site reclamation improvements are required as part of every permitted road construction and excavation project. A plan to control stormwater along the roadway to lessen the degree of concentration of stormwaters must be incorporated in the erosion control plan. The plan must incorporate erosion control and site restoration measures to 1) assure effective stabilization of soil materials so that displacement and transport of soil materials is minimized and 2) affect restoration of natural vegetative ground cover to disturbed areas. In many cases the most effective means of controlling erosion is reestablishment of vegetation on disturbed areas. It is recommended that natural vegetation be left intact to the greatest extent possible.

Recommendations for erosion control techniques and revegetation practices are outlined in Larimer County Stormwater Design Standards, June 20, 2005, Addendum to Volume 3 of the USDCM. If road construction will disturb one acre or greater, a Stormwater Construction Permit is required from the Colorado Department of Public Health and Environment.

### **G.7.10 Buffer Zones for Streams, Intermittent Streams and Wetlands**

For roads which follow perennial stream corridors, a minimum 50-foot buffer zone of undisturbed vegetation must be maintained between the roadway or from any fill

material generated by the construction of the road and the normal high-water line of the stream. Proper revegetation of cut and fill slopes or other means of erosion and stormwater control must be affected to protect water quality of the stream. The Engineer may grant deviations from this buffer requirement if it can be demonstrated that the effects of such construction will not degrade water quality.

Construction of roadways within intermittent streams or drainageways shall not be permitted except for purposes of crossings. Proper design to allow adequate flow of stormwater, as indicated by the normal high-water line, must be incorporated in the plan. A buffer of at least 20 feet of undisturbed ground and vegetative cover from the normal high-water line must be maintained for roadways paralleling these features.

A 50- foot buffer zone must be maintained for wetlands unless further encroachment has been approved by the U.S. Army Corps of Engineers. Delineation of the wetland may be required by a qualified person to properly identify the extent of the wetland boundaries.

### **G.7.11 General Considerations**

Planning and construction of these roads should take into consideration all aspects of the effects of such construction activities. Among these should be consideration of encroachment upon critical wildlife habitat, wetlands conservation, protection of water quality in local streams, ponds and lakes, esthetics, etc. Site specific variances from the above standards to mitigate such concerns shall be considered so long as roadway safety and emergency access are maintained. Applicants are encouraged to study these issues and seek help from appropriate agencies or individuals to assess all effects of the proposed construction as a part of the planning process.

### **G.7.12 Other Permits and Conditions**

Issuance of a Private Road Construction Permit does not exempt the applicant from acquiring other permits regarding other local, State or Federal requirements.

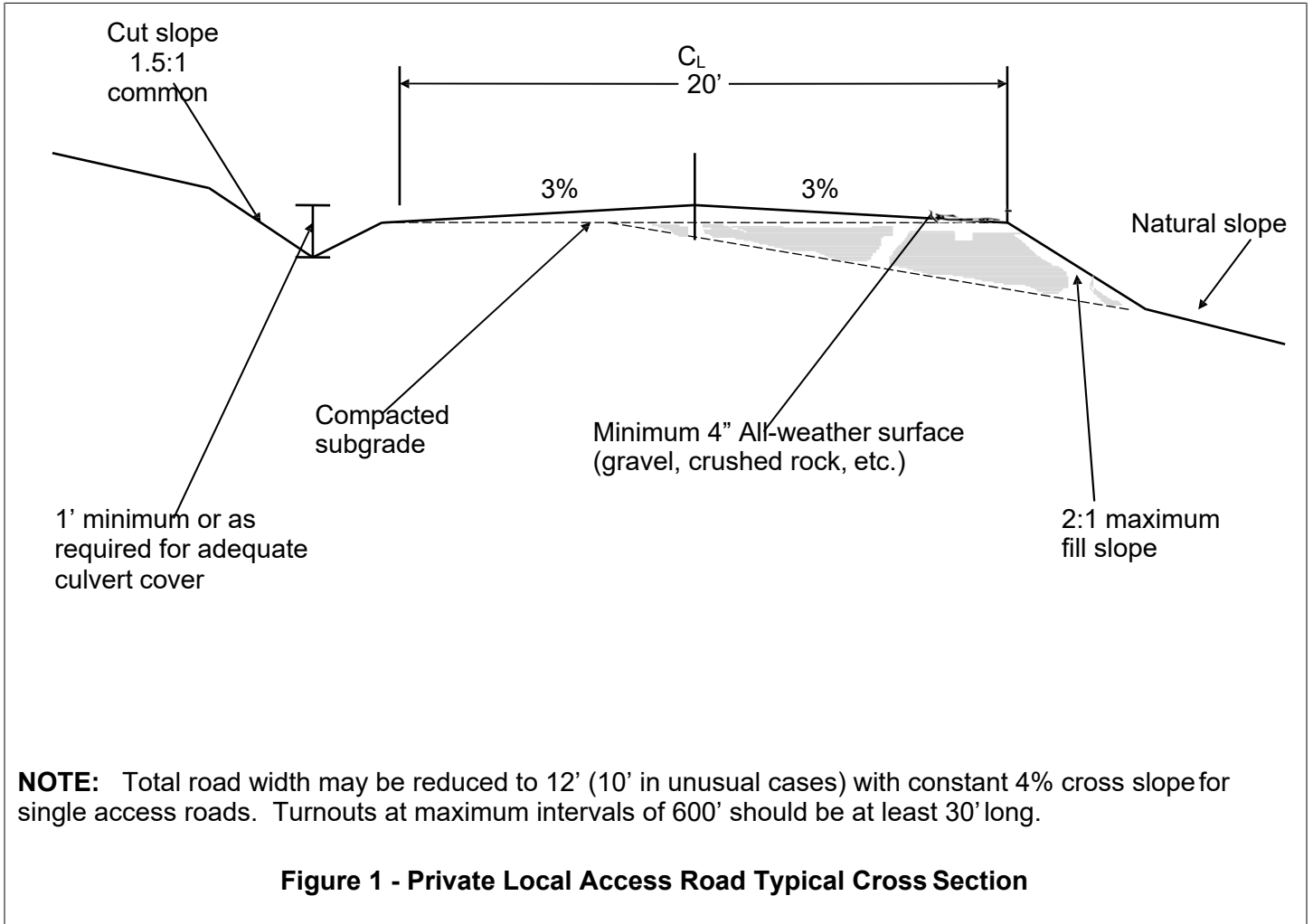

**Figure 1 - Private Local Access Road Typical Cross Section**

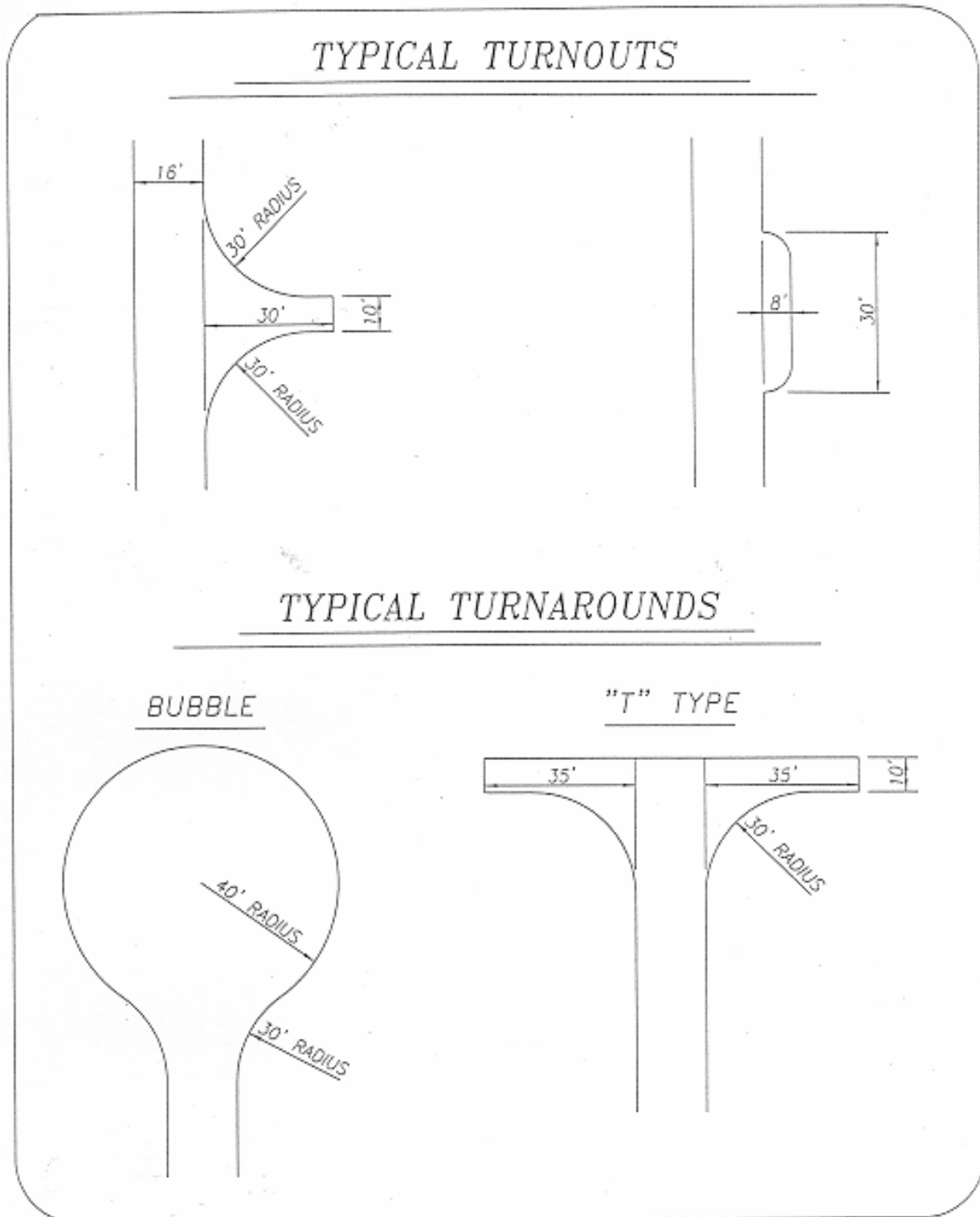
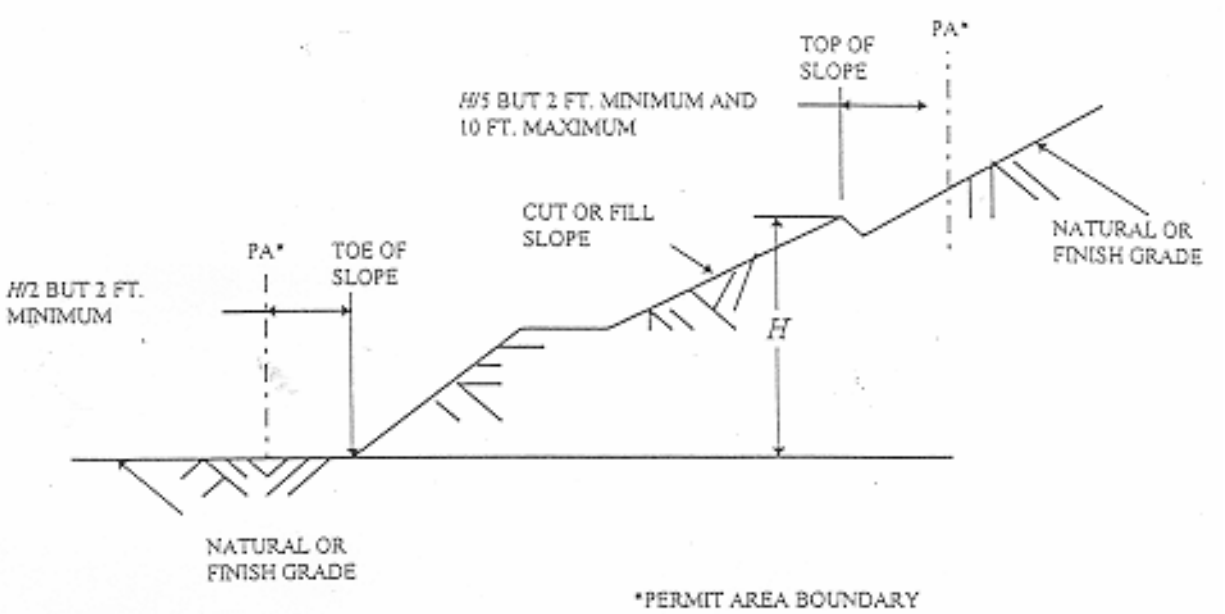

Figure 2. Minimum Geometric Requirements for Turnouts and Turnarounds



**Figure 3. Slope Setback Requirements**



**EXHIBIT 1**

Date August 23, 1999

**PUBLIC WORKS DIVISION APPEALS PROCESS  
ROAD CERTIFICATION - PRIVATE LOCAL ACCESS ROADS**

In the event that an applicant does not agree with a decision made pursuant to this regulation by an employee within the Engineering Department, the applicant may, by written request submitted to the Public Works Division not later than 30 days after the date the decision was made, appeal the decision to the County Engineer. The County Engineer will meet with the applicant and either affirm, reverse or modify the lower decision. If the County Engineer's decision is unsatisfactory to the applicant, the applicant may, by written request submitted to the Public Works Division not later than 30 days after the date the decision, appeal the decision to the Director of Public Works, who will meet with the applicant and either affirm, reverse or modify the lower decision.

In the event that the Director of Public Work's decision is unsatisfactory to the applicant, the applicant may, by written request, appeal the matter to the County Commissioners. The County Commissioners will hold a public hearing on the matter upon 15 days written notice to the applicant (which notice may be waived by the applicant) and render a written decision within a reasonable time thereafter.

---

Director of Public Works

# APPENDIX H – GENERAL NOTES

## H.1 PROFESSIONAL ENGINEER CERTIFICATION

Construction plans must include the following statement on the cover sheet:

*These construction plans for (name of subdivision, development, or project) were prepared by me (or under my direct supervision) in accordance with the requirements of the Road Standards and the Stormwater Design Standards for Larimer County."*

*Name of Engineer  
Name of Firm  
Date*

## H.2 INDEMNIFICATION STATEMENT

The engineer who has prepared these plans, by execution and/or seal hereof does hereby affirm responsibility to the county, as a beneficiary of said engineer's work, for any errors and omissions contained in these plans, and approval of these plans by the Larimer County Engineering Department shall not relieve the engineer who has prepared these plans of any such responsibility. Further, to the extent permitted by law, the engineer hereby agrees to hold harmless and indemnify Larimer County, and its officers and employees, from and against all liabilities, claims, and demands which may arise from any errors and omissions contained in the plans

## H.3 STANDARD SIGNATURE BLOCK

The standard signature block shall be all sheets including the cover sheet.

Reviewed by: \_\_\_\_\_  
LARIMER COUNTY ENGINEERING DATE

## H.4 GENERAL STANDARD NOTES FOR CONSTRUCTION PLANS

**Submissions shall include a General Notes sheet with the following General Notes, where applicable. Please contact the Larimer County Engineering Department for current General Notes.**

### A. General Notes

1. Larimer County **will not** be providing ongoing management, monitoring, inspection or supervision of this project to insure compliance with the approved construction drawings, and all applicable standards and specifications. This responsibility falls upon the developer/owner, their managers, engineers, and contractors. Upon project completion, Larimer County will require extensive documentation, such as professional engineer's site/drainage/material testing certification letters, material testing records, record drawings, and field inspection reports, to demonstrate that this project is in compliance with the approved construction drawings, and all applicable standards and specifications. These documents must be prepared by licensed engineers and land surveyors.
2. No work may commence within any improved or unimproved public Right-of-Way until a Right-of-Way Construction Permit and/or Development Construction Permit is obtained from the Larimer County Engineering Department.
3. Right of Way Construction Permits and Fees will be required for utility installations (i.e. phone, cable, gas, other dry utilities) and street cuts in Larimer County Right of Way. The fees will be paid prior to issuance of the Development Construction Permit and are a part of the Development Construction Permit issuance procedure.
4. The Developer shall be responsible for obtaining all necessary permits from all applicable agencies prior to commencement of construction. The Developer shall notify the Larimer County Engineering Department (498-5700) at least 2 working days prior to the start of any earth disturbing activity, or construction on any and all public improvements. If the Larimer County Engineering Department is not available after proper notice of construction activity has been provided, the Developer may commence work in the Engineer Departments absence. However, the Larimer County Engineering Department reserves the right not to accept the improvement if subsequent testing reveals an improper installation.
5. The Developer shall submit a Construction Traffic Control Plan, in accordance with MUTCD, to the Larimer County Engineering Department for approval, prior to any construction activities within, or affecting, the Right-of-Way. The Developer shall be responsible for providing any and all traffic control devices as may be required by the construction activities. The traffic control plan and associated implementation must be done by a certified traffic control company.
6. All materials, workmanship, and construction of public improvements shall meet or exceed the standards and specifications set forth in the *Larimer County Rural Area Road Standards* and applicable state and federal regulations. Where there is conflict between these plans and the specifications, or any applicable standards, the most restrictive standard shall apply.

7. All references to any published standards shall refer to the latest revision of said standard, unless specifically stated otherwise.
8. These public improvement construction plans shall be valid for a period of two years from the date of approval by the Larimer County Engineering Department. Use of these plans after the expiration date may require a new review and approval process by the Larimer County Engineering Department prior to commencement of any work shown in these plans.
9. All sanitary sewer, storm sewer, and water line construction, as well as power and other “dry” utility installations, shall conform to the Governing Authority standards and specifications current at the date of approval of the plans by the Larimer County Engineering Department.
10. It shall be the responsibility of the Developer to verify the existence and location of all underground utilities along the route of the work before commencing new construction. The Developer shall be responsible for unknown underground utilities.
11. The Developer shall be responsible for protecting all utilities during construction and for coordinating with the appropriate utility company for any utility crossings required or utility relocation due to a utility conflict with the proposed improvements shown on these plans. The developer shall complete any utility work in a timely fashion and with a minimum disruption of service and shall be responsible for contacting, in advance, all parties affected by any disruption of any utility service as well as the utility companies. The developer shall contact the Utility Notification Center of Colorado (UNCC) at 1-800-922-1987, at least 2 working days prior to beginning excavation or grading, to have all registered utility locations marked. Other unregistered utility entities (i.e. ditch / Irrigation Company) are to be located by contacting the respective representative. If a conflict exists between existing and proposed utilities and/or a design modification is required, the Developer shall coordinate with the engineer to modify the design. Design modification(s) must be approved by the Larimer County Engineering Department prior to beginning construction.
12. No work may commence on any public storm water, sanitary sewer or potable water system until the Developer notifies the utility provider. Notification shall be a minimum of 2 working days prior to commencement of any work. At the discretion of the water utility provider, a pre-construction meeting may be required prior to commencement of any work.
13. All utility installations within or across the roadbed of new residential roads must be completed prior to the final stages of road construction. For the purposes of these standards any work above the subgrade is considered final stage work. All service lines must be stubbed to the property lines and marked so as to reduce the excavation necessary for building connections.
14. Portions of Larimer County are within a floodplain overlay district. The Larimer County Land Use Code should be referred to for additional criteria for improvements within these districts.
15. The Developer shall be responsible for all aspects of safety including, but not limited to, excavation, trenching, shoring, traffic control, and security. Refer to OSHA Publication 2226, *Excavating and Trenching*.
16. The Work hours for any work requiring an Engineers inspection shall be 7:00 A.M. to 6:00 P.M.- Monday through Friday. More restrictive hours of operation

(9:00 A.M. to 3:00 P.M.) may be in place for mainline County Road improvements depending on the location and nature of the improvements being constructed. Work requiring an Engineers inspection will not be permitted on weekends or holidays, unless requested in writing by the contractor and approved by the County in writing.

17. The Developer is responsible for providing all labor and materials necessary for the completion of the intended improvements shown on these drawings, or designated to be provided, installed, or constructed, unless specifically noted otherwise.
18. Dimensions for layout and construction are not to be scaled from any drawing. If pertinent dimensions are not shown, contact the Designer for clarification, and annotate the dimension on the record drawings.
19. The Developer shall have, onsite at all times, one (1) signed copy of the approved plans, one (1) copy of the appropriate standards and specifications, and a copy of any permits and extension agreements needed for the job. If, during the construction process, conditions are encountered which could indicate a situation that is not identified in the plans or specifications, the Developer shall contact the Designer and the Larimer County Engineering Department immediately.
20. The Designer shall provide, in this location on the plan, the location and description of the nearest survey benchmarks (1) for the project as well as the basis of bearings. The information shall be as follows:  
Benchmarks—Local Entity survey.  
B.M.Number \_\_\_\_\_, Elev.= \_\_\_\_\_,  
Description \_\_\_\_\_.
21. All stationing is based on centerline of roadways unless otherwise noted.
22. Upon completion of construction, the site shall be cleaned and restored to a condition equal to, or better than, that which existed before construction, or to the grades and condition as required by these plans. Any existing improvements destroyed, damaged or removed due to construction of this project, shall be replaced or restored in like kind at the Developer's expense, unless otherwise indicated on these plans, prior to the acceptance of completed improvements.
23. The Larimer County Engineering Department shall not be responsible for the maintenance of roadway and appurtenant improvements, including storm drainage structures and pipes.
24. Approved Variances are listed as follows: (Plan set should have a list of all applicable variances for the project).

**B. Grading and Erosion Control Notes**

1. All grading and erosion control measures are subject to General Notes on the cover sheet of these plans as well as the Grading and Erosion Control Notes listed here.
2. A State Construction Dewatering Wastewater Discharge Permit is required if dewatering is required in order to install utilities or water is discharged into a storm sewer, channel, irrigation ditch or any waters of the United States.

3. The Developer shall comply with all terms and conditions of the Colorado Permit for Storm Water Discharge (Contact Colorado Department of Health, Water Quality Control Division, (303) 692-3590), the Storm Water Management Plan, and the Erosion Control Plan.
4. Temporary erosion control during construction shall be provided as shown on the Erosion Control Plan and shall be maintained in good repair by the Developer. Temporary erosion control measures shall not be removed until such time as all tributary-disturbed areas are sufficiently stabilized as determined by the Larimer County Engineering Department. When temporary erosion control measures are removed, the Developer shall be responsible for the clean-up and removal of all sediment and debris from all drainage and other public facilities.
5. Silt and sediment, within Right-of-Way, shall be removed after each substantial rainfall. The Developer shall be responsible for insuring that no mud or debris shall be tracked onto the existing public street system. Mud and debris must be removed within 24 hours by an appropriate mechanical method (i.e. machine broom sweep, light duty front-end loader, etc.) or as approved by Larimer County Engineering Department.
6. All perimeter erosion control measures shall be installed and functional, prior to any other earth-disturbing activity. All other structural erosion control measures shall be implemented as soon as the facilities, around which they are based, become operational.
7. Any erosion control facility damaged or destroyed prematurely, by any means, shall be immediately repaired by the Developer.
8. There shall be no earth-disturbing activity outside the limits designated on these plans.
9. Top soil shall be removed and stock piled prior to overlot grading operations.
10. Conditions in the field may warrant erosion control measures in addition to what is shown on these plans. The Developer shall implement whatever measures are determined necessary, as directed by the Larimer County Engineering Department.
11. Negative impacts to downstream areas caused by overlot grading are to be monitored and corrected by the Developer. Any off-site clean-up, directed by The Larimer County Engineering Department, (including street cleaning), shall be completed within 24-hours of written instruction, or risk construction stoppage.
12. All areas disturbed by this project shall be seeded and mulched in accordance with these specifications after grading completion.
  - a. All areas for seeding shall be tilled to break up rooting restrictive layers, have a minimum of 4 inches of topsoil reapplied, and then be harrowed, and rolled or packed, to prepare the required firm seed bed.
  - b. The seed bed shall be well-settled and firm, but friable enough so that seed can be placed at the seeding depths specified. The seed bed shall be reasonably free of weeds.
  - c. All seeding areas shall be fertilized, unless field evidence or laboratory soil analysis indicates sufficient amounts of nitrogen (N) and 40 pounds available phosphate (P205) per acre. Time of application will be as applicable to the kind of fertilizer and type of equipment used.

- d. Seed shall be planted with a drill on all slopes of 3:1 or flatter. The drill must have the capability of handling the kind and rate of seed being planted. Seed may be broadcast by mechanical spreader, or by hydraulic equipment on areas that are small, too steep, or not accessible for drill seed-operations. Seeding rates shall be doubled when using broadcast or hydraulic seeding. Hydro mulching is allowed on slopes steeper than 4:1.
  - e. Seed planted with a drill shall be covered with soil to a depth of 1/4 to 3/4 inch. Seed planted by the broadcast method shall be incorporated into the surface soil, to a maximum depth of 3/4 inch, by raking, harrowing, or other proven methods.
  - f. Mulch shall consist of either cereal grain straw or grass hay, at least 50% by weight, being 10 inches or longer. Application rate to be 2000 lbs/acre to achieve a stubbled surface. Anchoring with a mulch crimper is acceptable, or with the use of a disc plow, set vertical to the ground with sufficient weight to achieve a crimping depth of at least 4 inches into the soil. All mulched areas shall be tackified after crimping. Tackifier, whether placed on soil or mulch, shall conform to the **Colorado Highway Specifications, Section 213.02**. Apply tackifier with a spray nozzle, dispensing a mist that will uniformly cover the surface.
  - g. All seeded areas shall be mulched, crimped, and tackified within 24 hours after seeding; otherwise, areas shall be reseeded, at the Developer's expense, prior to the mulching, crimping, and tackifying.
  - h. All slopes steeper than 4:1 shall be tackified after the completion of seeding and fertilizing. Steep slopes or areas with unstable soil may also require soil retention blankets. Soil retention blankets shall be placed smoothly, but loosely, on the soil surface, without stretching. The upslope end shall be buried in a trench 6 inches wide by 6 inches deep beyond the crest of the slope, to avoid undercutting. There shall be a 6-inch overlap wherever one roll of blanket ends and another begins, with the uphill blanket placed on top of the downhill blanket. There shall be a 4-inch overlap wherever 2 widths of blanket are applied side by side. Insert staples in a pattern according to the manufacturer's recommendation, at approximately 2 staples per square yard. "T" shaped pins shall not be used.
  - i. To aid in germination, some form of irrigation may be required and it is the responsibility of the Developer to perform any and all necessary operations to that end.
13. The following is the specific seed mix to be used at this site (*insert mix*):

#### C. Street Improvements Notes

- 1. All street construction is subject to the General Notes on the cover sheet of these plans as well as the Street Improvements Notes listed here.
- 2. The Larimer County Engineering Department should be notified of utility work, subgrade proof rolls, base course proof rolls, and paving operations. In addition, one or both of the Developer/Owner's Inspecting Engineer and the Developer/Owner's Materials Testing Engineer should be present. The Larimer County Engineering Department should be given at least twenty-four hours advance notice. If a Larimer County Engineering Department representative can

not be present for these activities, these activities may still be conducted, as long as the Developer/owner's Inspecting Engineer and/or the Developer/Owner's Materials Engineer are present.

3. Proof rolls should be performed on subgrade prior to placement of road base, and on road base prior to placement of asphalt. All failed areas or material which exhibits excessive pumping or deformation shall be reworked, replaced or otherwise modified to form a smooth, non-yielding surfaces. Following precipitation, all areas should be re-proofrolled as needed based upon the evaluation of the Larimer County Engineering Department. Chemically treated subgrade will require proofrolling to demonstrate the adequacy of the chemical stabilization. Non paved roads will only require one proofroll on subgrade prior to placement of road base to demonstrate stability, however it is strongly recommended that additional proofrolls be performed by the contractor. Proofroll inspection and compaction test results must be approved by the Developer/Owner's Materials Testing Engineer.
4. For a mechanical "proof roll", the entire subgrade and/or base material must be rolled with a heavily loaded vehicle having a total GVW of not less than 50,000 lbs. and a single axle weight of at least 18,000 lbs. with pneumatic tires inflated to not less that 90 p.s.i.g. "Proof roll" vehicles shall not travel at speeds greater than 3 m.p.h. during the proofroll.
5. The pavement section design, signed and stamped by a Colorado licensed Engineer, should be included in the construction plan set. Prior to paving, the asphalt mix design must be approved and certified by the Larimer County Engineering Department.
6. Where proposed paving adjoins existing asphalt, the existing asphalt shall be saw cut from the existing edge to create a clean construction joint. The Developer shall be required to remove existing pavement to a distance where a clean construction joint can be made. Wheel cuts shall not be allowed.
7. The top 12 inches of street subgrades shall be scarified and re-compacted prior to subbase installation. No base material shall be laid until the subgrade has been inspected and approved by the Developers material testing engineer.
8. Valve boxes and manholes are to be brought up to grade at the time of pavement placement or overlay. Valve box adjusting rings are not allowed, unless otherwise directed by the utility company.
9. When an existing asphalt street must be cut, the street must be restored to a condition equal to or better than its original condition. The existing street condition shall be documented by the Larimer County Engineering Department before any cuts are made. Patching shall be done in accordance with the Larimer County Street Repair Requirements specified in the Larimer County Rural Road Standards. The finished patch shall blend in smoothly into the existing surface. All large patches shall be paved with an asphalt lay-down machine. In streets where more than one cut is made, an overlay of the entire street width, including the patched area, may be required. The determination of need for a complete overlay shall be made by the Larimer County Engineering Department at the time the cuts are made.
10. All traffic control devices shall be in conformance with these plans or as otherwise specified in M.U.T.C.D. (including Colorado supplement) and as per the Right-of-Way Construction Permit traffic control plan.



11. Signage, such as site entrance signs, will not be allowed within the ROW of Larimer County roads that are external to and/or adjacent to the development construction project. Please note that all signs that are not a part of the approved construction plans will require a separate sign permit from the Larimer County Building Department.
12. The project materials testing engineer shall take asphalt cores. These cores shall be taken to verify asphalt layer thickness and the thickness of the aggregate base course. Asphalt cores should not be larger than 4 inches in diameter. Asphalt coring can be performed on the completed section once all lifts of asphalt have been placed. Asphalt coring frequency shall be, at a minimum, every 500 feet across the centerline and at least one core for an auxiliary turn bay. All core-drilled holes shall be flow filled, vibrated and then topped with HBP or permapatch material. permapatch.
13. When improvements are made to Larimer County Roads, such as paving gravel roads, all survey monuments must be improved and upgraded per the State of Colorado standards. This may include, but is not necessarily limited to, raising and upgrading monuments and the placement of a range box at each monument.
14. All recommendations of the final geotechnical engineering study (name of the study and date) by (Engineering Firm) shall be followed and implemented.

D. Traffic Signing and Pavement Marking Construction Notes

1. Prior to the commencement of any construction that will affect traffic signs of any type; the contractor shall contact the Larimer County Engineering Department.
2. The Developer is responsible for all costs for the initial installation of traffic signing and striping for the Development
3. All symbols, including arrows, ONLYS, crosswalks, stop bars, etc. shall be 0.125 mil pre-formed thermo-plastic.
4. All lane lines for asphalt pavement shall receive one coat of latex paint with glass beads, unless otherwise specified by the Engineer and/or in these plans.
5. All lane lines for concrete pavement should be epoxy paint.
6. Prior to permanent installation of traffic striping and symbols, the Developer shall place temporary tabs or tape depicting alignment and placement of the same. Their placement shall be approved by the Larimer County Engineering Department prior to permanent installation of striping and symbols.
7. Pre-formed thermo-plastic applications and epoxy applications shall be applied as specified in CDOT Standard Specifications for Road and Bridge Construction.
8. All surfaces shall be thoroughly cleaned prior to installation of striping or markings.
9. All signage shall be per Larimer County Standards and these plans or as otherwise specified in MUTCD.
10. A field inspection of location and installation of all signs shall be performed by the Larimer County Engineering Department. All discrepancies identified during the field inspection must be corrected before the 2-year warranty period will begin.
11. The Developer installing signs shall be responsible for locating and protecting all underground utilities.

12. Special care shall be taken in sign location to ensure an unobstructed view of each sign.
13. Signage and striping has been determined by information available at the time of review. Prior to initiation of the warranty period, the Engineer reserves the right to require additional signage and/or striping if the Engineer determines that an unforeseen condition warrants such signage according to the MUTCD or the CDOT *M and S Standards*. All signage and striping shall fall under the requirements of the 2-year warranty period for new construction (except fair wear on traffic markings).
14. Sleeves for sign posts shall be required for use in islands/medians.
15. Roadside delineators shall be as specified in the MUTCD or the CDOT M and S Standards.

E. Storm Drainage Notes

1. The Larimer County Engineering Department shall not be responsible for the maintenance of storm drainage facilities located on private property or in developments. Maintenance of onsite drainage facilities shall be the responsibility of the property owner(s).
2. All recommendations of the final drainage and erosion control study (name of the study and date) by (Engineering Firm) shall be followed and implemented.
3. Prior to final inspection and acceptance by The Larimer County Engineering Department, certification of the drainage facilities, by a registered engineer, must be submitted to and approved by the Engineering Department.

F. Waterline Note

1. The minimum cover over water lines is 4.5 feet and the maximum cover is 5.5 feet unless otherwise noted in the plans and approved by the governing Water Utility.

**APPENDIX I – VARIANCE REQUEST SUBMITTAL FORM**



(COUNTY USE ONLY)

Approved  
Denied

Signature: \_\_\_\_\_

Date: \_\_\_\_\_

**LARIMER COUNTY ROAD STANDARDS  
VARIANCE REQUEST SUBMITTAL FORM**

Project Name: \_\_\_\_\_

Project Location: \_\_\_\_\_

\_\_\_\_\_

Identify the Larimer County Rural Area Road Standards (RARS) standard that is being requested to be waived or varied and reference the appropriate section number.

\_\_\_\_\_

\_\_\_\_\_

\_\_\_\_\_

On a separate sheet, please address the following:

- Note why the standard is unfeasible or is not in the public interest.
- Identify the proposed alternative design or construction criteria.
- Compare the proposed design with the standard specified in the RARS and note what impacts the proposed design will have upon capital, maintenance requirements, and costs.

---

“I hereby certify that that the variance will not be detrimental to the public health, safety, and welfare nor will it reduce the design life of the improvement or cause Larimer County additional maintenance costs.”

Signature of Engineer: \_\_\_\_\_ Date: \_\_\_\_\_

Attach Seal & Signature